

Configuring JMS on Weblogic Server 12c  
Oracle Banking Treasury Management  
Release 14.4.0.3.0  
[February] [2021]



---

# Table of Contents

<b>1. INTRODUCTION</b>	<b>1-2</b>
1.1 INTRODUCTION	1-2
1.2 PURPOSE	1-2
1.3 WEBLOGIC 12C NEW FEATURES	1-3
1.4 COMPONENTS DIAGRAM & DATA FLOW	1-4
<b>2. PRE-REQUISITES</b>	<b>2-1</b>
2.1 MACHINES	2-1
2.2 DYNAMIC CLUSTERS AND MANAGED SERVERS	2-1
2.3 DATASOURCE	2-2
2.4 SHARED FOLDER	2-2
<b>3. JMS CONFIGURATION</b>	<b>3-1</b>
3.1 PERSISTENCE STORE CREATION	3-1
3.2 JMS SERVER CREATION	3-3
3.3 CLUSTER CONFIGURATION FOR SERVICE MIGRATION	3-5
<b>4. JMS MODULE CREATION</b>	<b>4-6</b>
4.1 MODULE CREATION	4-6
4.2 SUB DEPLOYMENT CREATION	4-8
4.3 RESOURCE CREATION	4-10
4.3.1 Queue Creation	4-10
4.3.2 Connection Factory Creation	4-13
<b>5. SERVER RESTART</b>	<b>5-17</b>
<b>6. FOREIGN SERVER CREATION</b>	<b>6-1</b>
6.1 MODULE CREATION	6-1
6.2 FOREIGN SERVER CREATION	6-3
6.3 FOREIGN SERVER CONFIGURATION	6-7
<b>7. APPLICATION DEPLOYMENT</b>	<b>7-1</b>
<b>8. FREQUENTLY ASKED QUESTIONS</b>	<b>8-2</b>
8.1 APPLICATION AND JMS CLUSTER DEPLOYED ON SAME CLUSTER	8-2
8.2 APPLICATION SHOWS WARNING UPON RESTART OF MANAGED SERVERS	8-2
8.3 SECURING FILE STORE DATA	8-3
8.4 T3S PROTOCOL	8-3
8.5 HOW TO TEST THE DEPLOYMENT	8-3
8.6 INCREASE MAXIMUM NUMBER OF MESSAGE-DRIVEN BEAN THREADS	8-5
8.6.1 Modify weblogic-ejb-jar.xml	8-5
8.6.2 Work Manager Creation	8-6
8.7 HOW HIGH AVAILABILITY IS ACHIEVED	8-9
8.8 HOW TO SETUP FOR SCHEDULER/NOTIFICATIONS	8-10
8.9 WHAT OTHER MODULES USES JMS QUEUE'S	8-10
8.10 REFERENCES	8-10

---

# 1. Introduction

## 1.1 Introduction

Below is brief description on major components in Weblogic JMS Server architecture.

## 1.2 Purpose

The purpose of this document is to explain the steps required for JMS Configuration for

- 1) OBTRM 14.4.0.0.0
- 2) WebLogic Server 12.1.4.0.0

### JMS Server

JMS server acts as management container for JMS queue and topic resources defined within JMS modules that are targeted to specific that JMS server. A JMS server's main responsibility is to maintain persistent storage for these resources, maintain the state of durable subscriber and etc. JMS servers can host a defined set of modules and any associated persistent storage that reside on a WebLogic Server instance

### JMS Module

JMS modules are application-related definitions that are independent of the domain environment. JMS modules group JMS configuration resources (such as queues, topics, and connections factories). These are outside domain configuration. JMS modules are globally available for targeting to servers and clusters configured in the domain and therefore are available to all the applications deployed on the same targeted. JMS modules contain configuration resources, such as standalone queue and topic destinations, distributed destinations, and connection factories.

### Subdeployment

Subdeployment is also known as Advanced Targeting. Subdeployment resource is a bridge between the group of JMS resources and JMS Servers. When you create a JMS resource you need to choose one Subdeployment.

### JMS Resources

- 1) **Queue** defines a point-to-point destination type, which are used for asynchronous peer communications. A message delivered to queue is distributed to only one customer.
- 2) **Topic** defines a publish/subscribe destination type, which are used for asynchronous peer communication. A message delivered to topic is distributed to all topic consumers
- 3) **Distributed queue** defines a set of queues that are distributed on multiple JMS servers, but are accessible as a single, logical queue to JMS clients
- 4) **Distributed topic** defines a set of topics that are distributed on multiple JMS servers, but which as accessible as a single, logical topic to JMS clients.

- 5) **Uniform Distributed Queue:** queue members are created uniformly from a common configuration.

### Persistence store

A persistent store provides a built-in, high-performance storage solution for weblogic server subsystems and services that required persistence. There are two type of mechanism to store the message

- 1) File based persistence store → Message is stored in a file
- 2) DB based persistence store → Message is stored in Database.

## 1.3 Weblogic 12c New Features

Before weblogic 12c JMS Servers and stores are targeted to individual WLS Servers. Scaling up requires configure the JMS server, the store and target it to new WLS Server

In 12c JMS Servers and stores are targeted to WLS cluster. Scaling up requires to add a WLS server to the cluster.

### Architecture previous to 12c

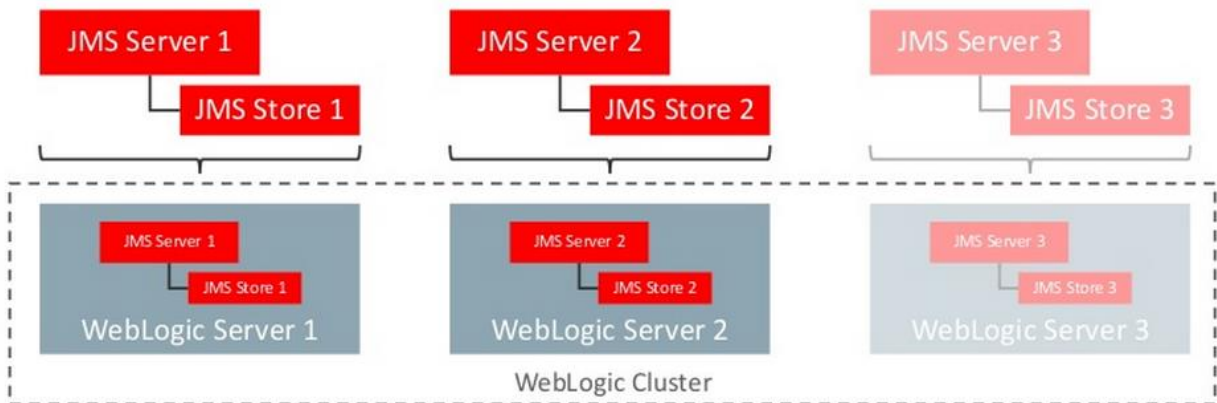

### Architecture in 12c

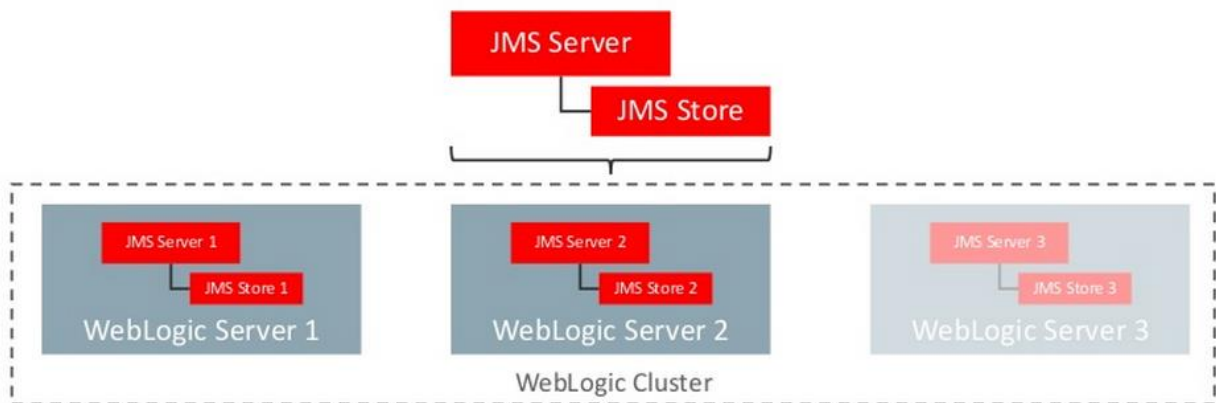

# 1.4 Components Diagram & Data Flow

Below is the flow diagram which indicates various components that are used and the document explain steps to create.

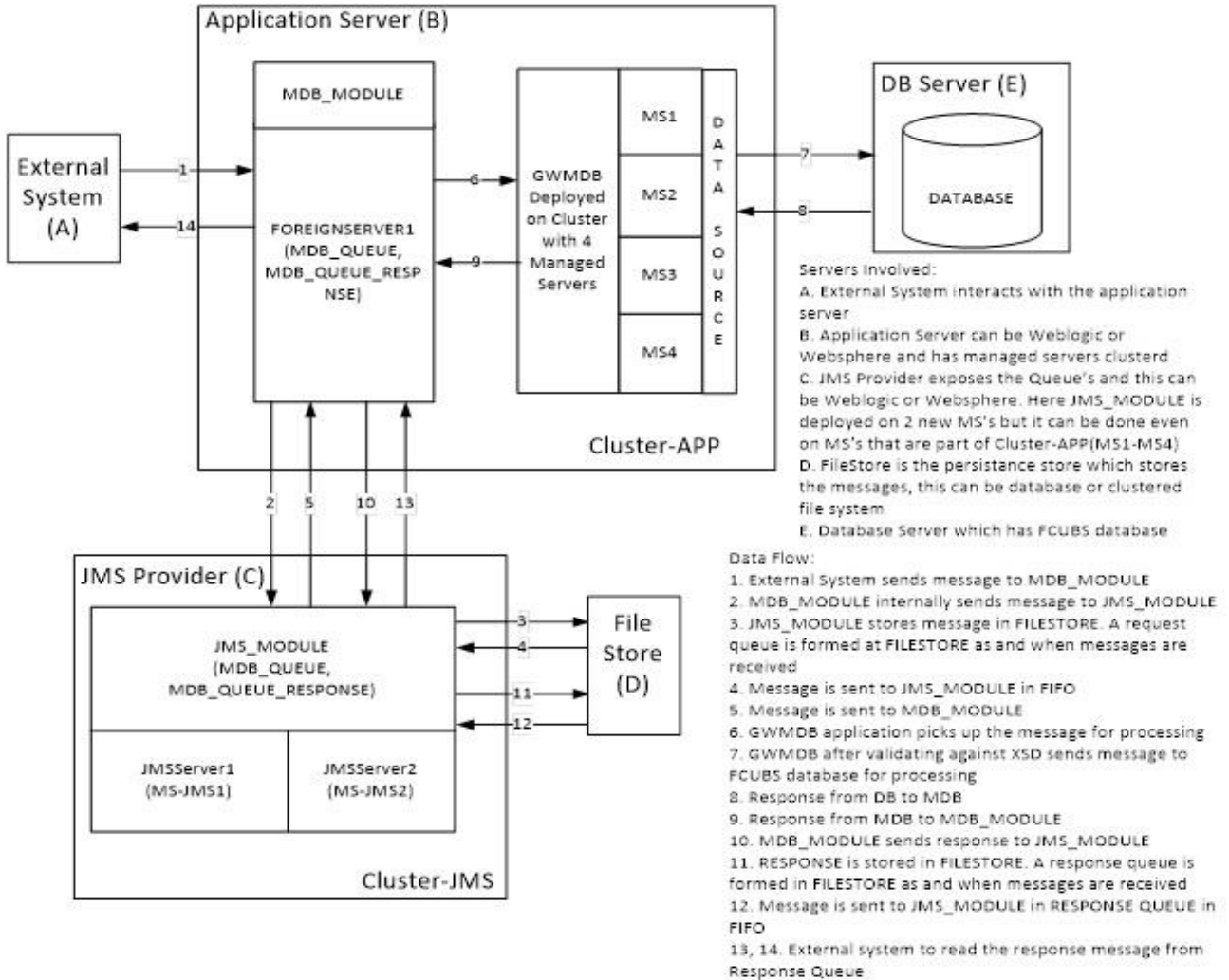

## 2. Pre-Requisites

The document assumes that the below are created before proceeding JMS creation.

### 2.1 Machines

MAC-1 & MAC-2

ORACLE WebLogic Server Administration Console 12c

Home > Summary of Servers > Summary of Machines

**Summary of Machines**

A machine is the logical representation of the computer that hosts one or more WebLogic Server instances (servers). WebLogic Server uses configured machine names to determine the optimum server in a cluster to which certain tasks, such as HTTP session replication, are delegated. The Administration Server uses the machine definition in conjunction with Node Manager to start remote servers.

This page displays key information about each machine that has been configured in the current WebLogic Server domain.

**Customize this table**

**Machines**

Name	Type
MAC-1	Machine
MAC-2	Machine

### 2.2 Dynamic Clusters and Managed Servers

Ensure Dynamic cluster for OBTRM (4 Managed Servers) and Dynamic cluster for JMS Deployment (2 Managed Servers)

ORACLE WebLogic Server Administration Console 12c

Home > Summary of Servers > Summary of Clusters > Summary of Server Templates > Summary of Clusters > Summary of Servers > Summary of Clusters > Summary of Server Templates > Summary of Clusters > Summary of Servers > Summary of Clusters

**Summary of Clusters**

This page summarizes the clusters that have been configured in the current WebLogic Server domain.

A cluster defines groups of WebLogic Server servers that work together to increase scalability and reliability.

**Customize this table**

**Clusters (Filtered - More Columns Exist)**

Click the **Lock & Edit** button in the Change Center to activate all the buttons on this page.

Name	Cluster Address	Cluster Messaging Mode	Migration Basis	Default Load Algorithm	Replication Type	Cluster Broadcast Channel	Servers
Cluster-App		Unicast	Database	Round Robin	(None)		DC_FCUBS_1, DC_FCUBS_2, DC_FCUBS_3, DC_FCUBS_4
Cluster-JMS		Unicast	Database	Round Robin	(None)		DC_JMS_1, DC_JMS_2

**Summary of Servers**

A server is an instance of WebLogic Server that runs in its own Java Virtual Machine (JVM) and has its own configuration. This page summarizes each server that has been configured in the current WebLogic Server domain.

**Servers (Filtered - More Columns Exist)**

Name	Type	Cluster	Machine	State	Health	Listen Port
AdminServer (admin)	Configured			RUNNING	OK	7001
DC_FCUBS_1	Dynamic	Cluster-App	MAC-1	SHUTDOWN	Not reachable	7101
DC_FCUBS_2	Dynamic	Cluster-App	MAC-2	SHUTDOWN	Not reachable	7102
DC_FCUBS_3	Dynamic	Cluster-App	MAC-1	SHUTDOWN	Not reachable	7103
DC_FCUBS_4	Dynamic	Cluster-App	MAC-2	SHUTDOWN	Not reachable	7104
DC_JMS_1	Dynamic	Cluster-JMS	MAC-1	SHUTDOWN	Not reachable	7106
DC_JMS_2	Dynamic	Cluster-JMS	MAC-2	SHUTDOWN	Not reachable	7107

## 2.3 DataSource

Ensure that DataSource required for the MDB ear is created with Target as Cluster-App

**Summary of JDBC Data Sources**

A JDBC data source is an object bound to the JNDI tree that provides database connectivity through a pool of JDBC connections. Applications can look up a data source on the JNDI tree and then borrow a database connection from a data source. This page summarizes the JDBC data source objects that have been created in this domain.

**Data Sources (Filtered - More Columns Exist)**

Name	Type	JNDI Name	Targets
FLEXTTEST.WORLD	Generic	FLEXTTEST.WORLD	Cluster-App

## 2.4 Shared Folder

A shared folder for File Store Creation is required and this folder should be accessible across both the servers (eg, NFS mount).

## 3. JMS Configuration

### 3.1 Persistence Store Creation

- 1) Navigate to Services → Persistent Stores → New → Create FileStore

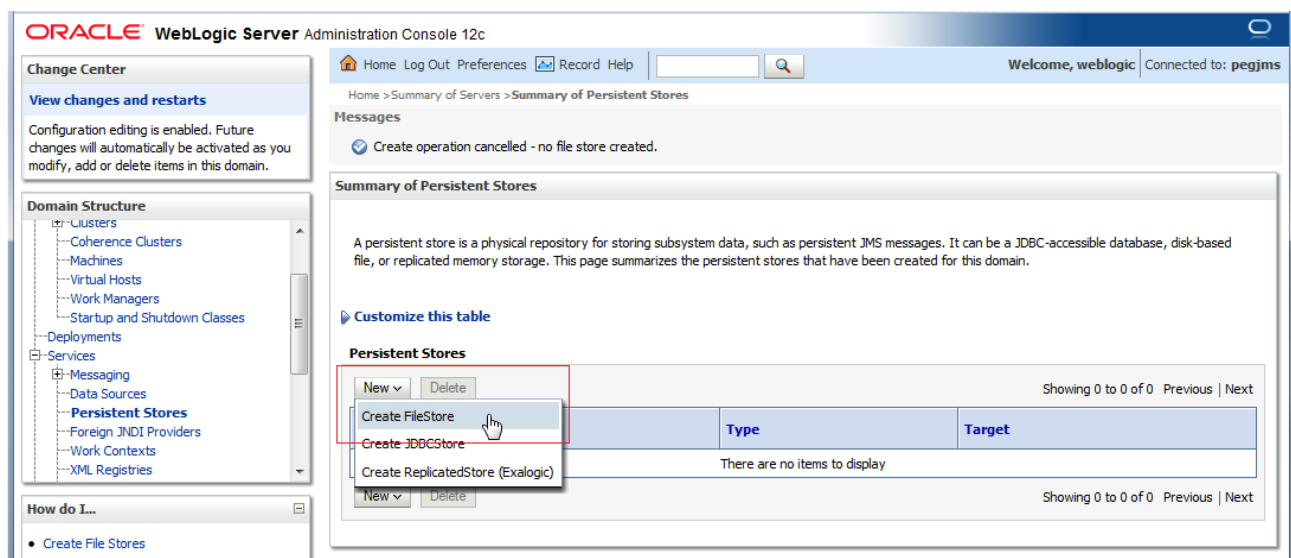
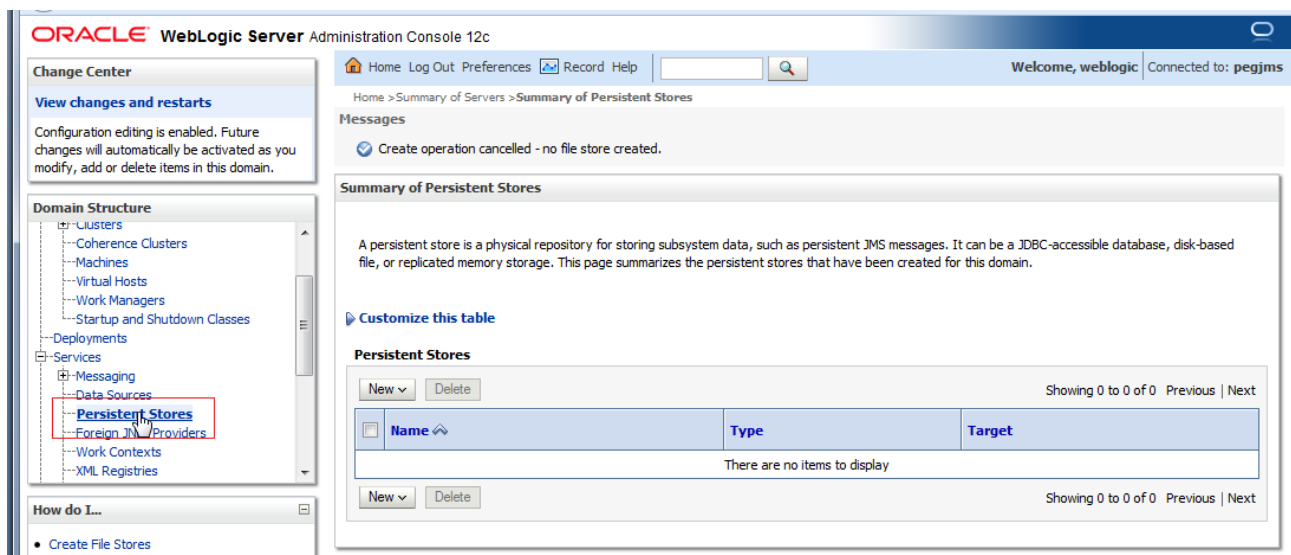



2) Select **Cluster-JMS** under target dropdown and Click on OK

**ORACLE WebLogic Server Administration Console 12c**

Home > Summary of Clusters > Summary of Servers > Summary of Clusters > Summary of Servers > Summary of Clusters > Cluster-JMS > Summary of Servers > Summary of Clusters > Summary of Servers > Summary of Persistent Stores

Welcome, weblogic | Connected to: FCUBSDomain

**Create a New File Store**

OK | Cancel

**File Store Properties**

The following properties will be used to identify your new file store.  
\* Indicates required fields

What would you like to name your new file store?

\* **Name:**

Select a server instance for this file store.

**Target:**

The pathname to the directory on the file system where the file store is kept. This directory must exist on your system, so be sure to create it before completing this tab.

**Directory:**

OK | Cancel

3) **FileStore-1** is created

**ORACLE WebLogic Server Administration Console 12c**

Home > Summary of Clusters > Summary of Servers > Summary of Clusters > Summary of Servers > Summary of Clusters > Cluster-JMS > Summary of Servers > Summary of Clusters > Summary of Servers > Summary of Persistent Stores

Welcome, weblogic | Connected to: FCUBSDomain

**Messages**

✔ All changes have been activated. No restarts are necessary.

**Summary of Persistent Stores**

A persistent store is a physical repository for storing subsystem data, such as persistent JMS messages. It can be a JDBC-accessible database, disk-based file, or replicated memory storage. This page summarizes the persistent stores that have been created for this domain.

Customize this table

**Persistent Stores**

Click the **Lock & Edit** button in the Change Center to activate all the buttons on this page.

New | Delete

Name	Type	Target
<input type="checkbox"/> FileStore-1	FileStore	Cluster-JMS

New | Delete

Showing 1 to 1 of 1 Previous | Next

## 3.2 JMS Server Creation

- 1) Navigate to Services → Messaging → JMS Servers → Click on **New**

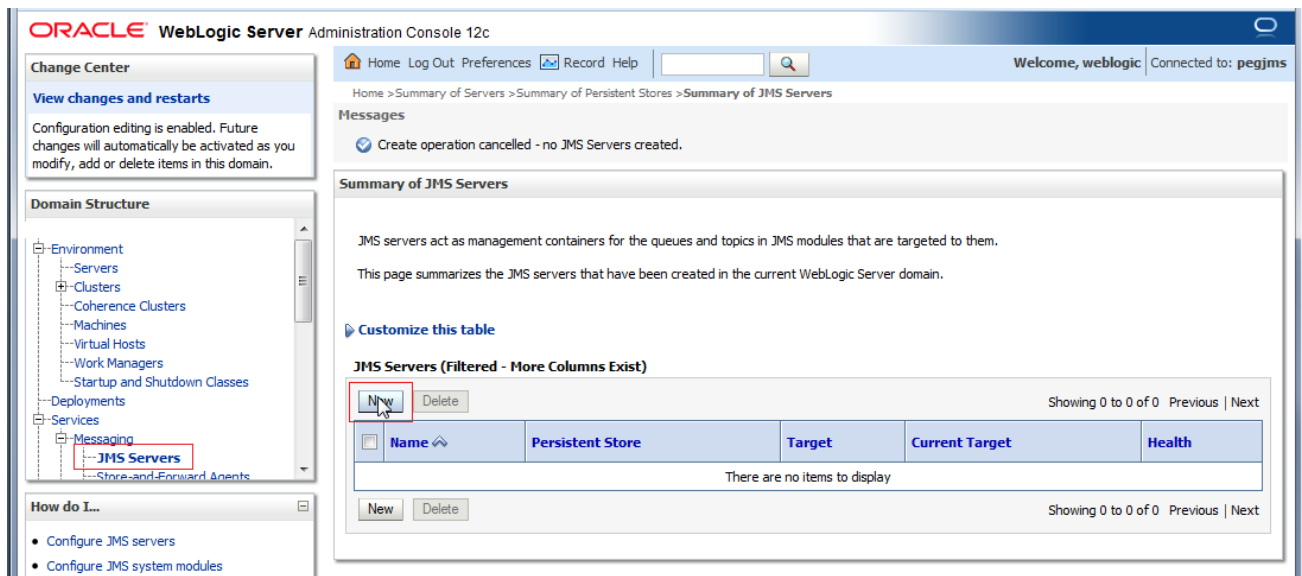

- 2) Select FileStore-1, Click **Next**

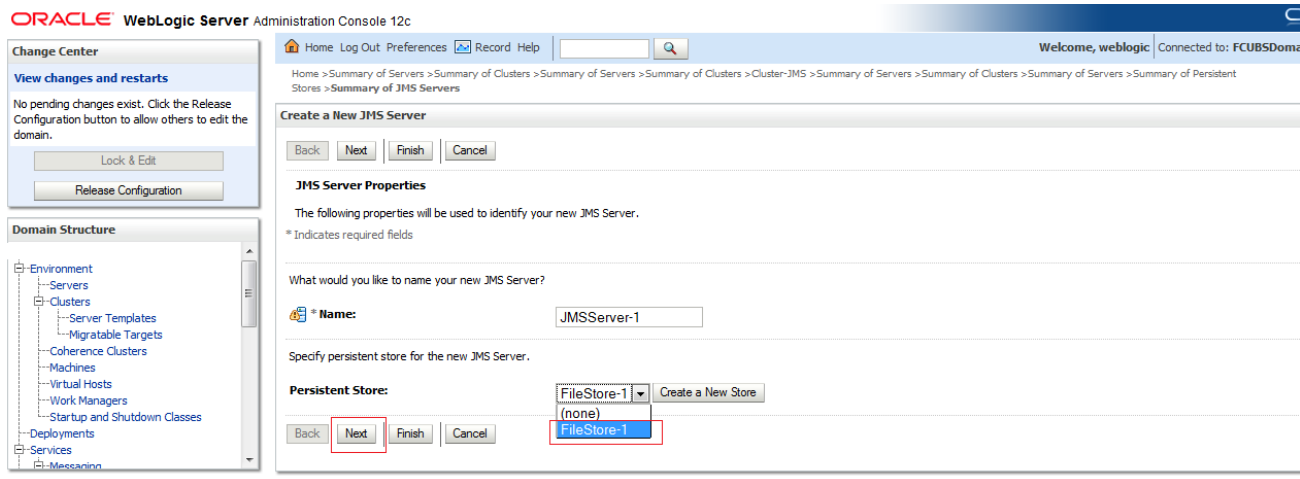

- 3) Select Target as Cluster-JMS and click on **Finish**

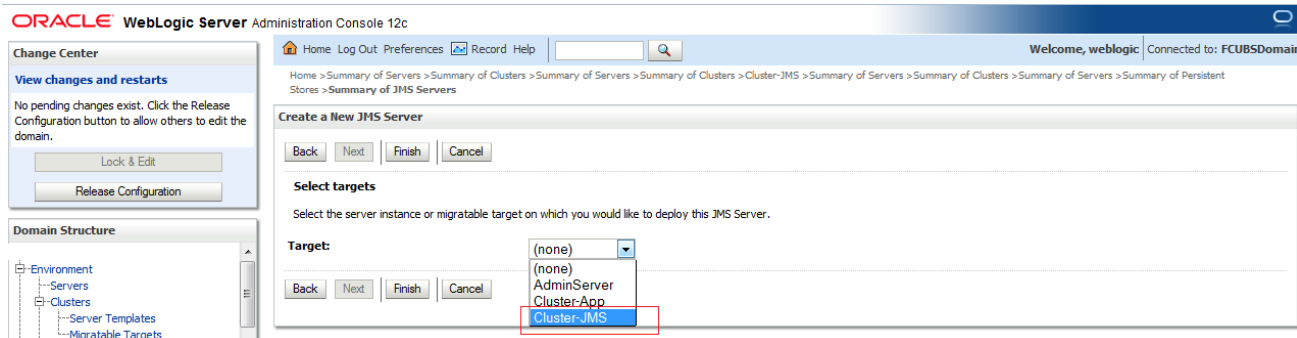

ORACLE WebLogic Server Administration Console 12c

Home Log Out Preferences Record Help

Welcome, weblogic Connected to: FCUBSDomain

Home > Summary of Servers > Summary of Clusters > Summary of Servers > Summary of Clusters > Cluster-JMS > Summary of Servers > Summary of Clusters > Summary of Servers > Summary of Persistent Stores > Summary of JMS Servers

**Create a New JMS Server**

Back Next Finish Cancel

**Select targets**

Select the server instance or migratable target on which you would like to deploy this JMS Server.

Target: Cluster-JMS

Back Next Finish Cancel

4) JMS-Server-1 is created

ORACLE WebLogic Server Administration Console 12c

Home Log Out Preferences Record Help

Welcome, weblogic Connected to: FCUBSDomain

Home > Summary of Servers > Summary of Clusters > Summary of Servers > Summary of Clusters > Cluster-JMS > Summary of Servers > Summary of Clusters > Summary of Servers > Summary of Persistent Stores > Summary of JMS Servers

**Messages**

All changes have been activated. No restarts are necessary.

**Summary of JMS Servers**

JMS servers act as management containers for the queues and topics in JMS modules that are targeted to them.

This page summarizes the JMS servers that have been created in the current WebLogic Server domain.

Customize this table

**JMS Servers (Filtered - More Columns Exist)**

Click the **Lock & Edit** button in the Change Center to activate all the buttons on this page.

New Delete Showing 1 to 1 of 1 Previous Next

Name	Persistent Store	Target	Current Target	Health
JMSServer-1	FileStore-1	Cluster-JMS	Cluster-JMS	

New Delete Showing 1 to 1 of 1 Previous Next

**How do I...**

- Configure JMS servers
- Configure JMS system modules

5) In NFS below filestores can be seen

```

[root@          JMS_FILESTORE]# ll
total 2056
-rw-r----- 1 wll2c oinstall 1049088 Jun 16 14:10 FILESTORE-1@DC_JMS_1000000.DAT
-rw-r----- 1 wll2c oinstall 1049088 Jun 16 14:10 FILESTORE-1@DC_JMS_2000000.DAT
[root@          JMS_FILESTORE]# pwd
/scratch/work_area/JMS_FILESTORE
[root@          JMS_FILESTORE]#

```

### 3.3 Cluster Configuration for Service Migration

1) Click on Environment → Clusters → Cluster-JMS

The screenshot shows the Oracle WebLogic Server Administration Console. On the left, the 'Domain Structure' tree has 'Clusters' selected. The main area displays the 'Summary of Clusters' page. A table lists two clusters: 'Cluster-App' and 'Cluster-JMS'. The 'Cluster-JMS' row is highlighted with a red box.

Name	Cluster Address	Cluster Messaging Mode	Migration Basis	Default Load Algorithm	Replication Type	Cluster En
Cluster-App		Unicast	Database	Round Robin	(None)	
Cluster-JMS		Unicast	Database	Round Robin	(None)	

2) Click on **Migration** Tab

The screenshot shows the 'Settings for Cluster-JMS' page. The 'Migration' tab is selected and highlighted with a red box. Other tabs include Configuration, Monitoring, Control, Deployments, Services, and Notes. The 'Migration' sub-tab is also highlighted.

3) Change Migration Basis to Consensus and Click on **Save**

## 4. JMS Module Creation

### 4.1 Module Creation

- 1) Navigate to Services → Messaging → JMS Modules and Click on **New**.

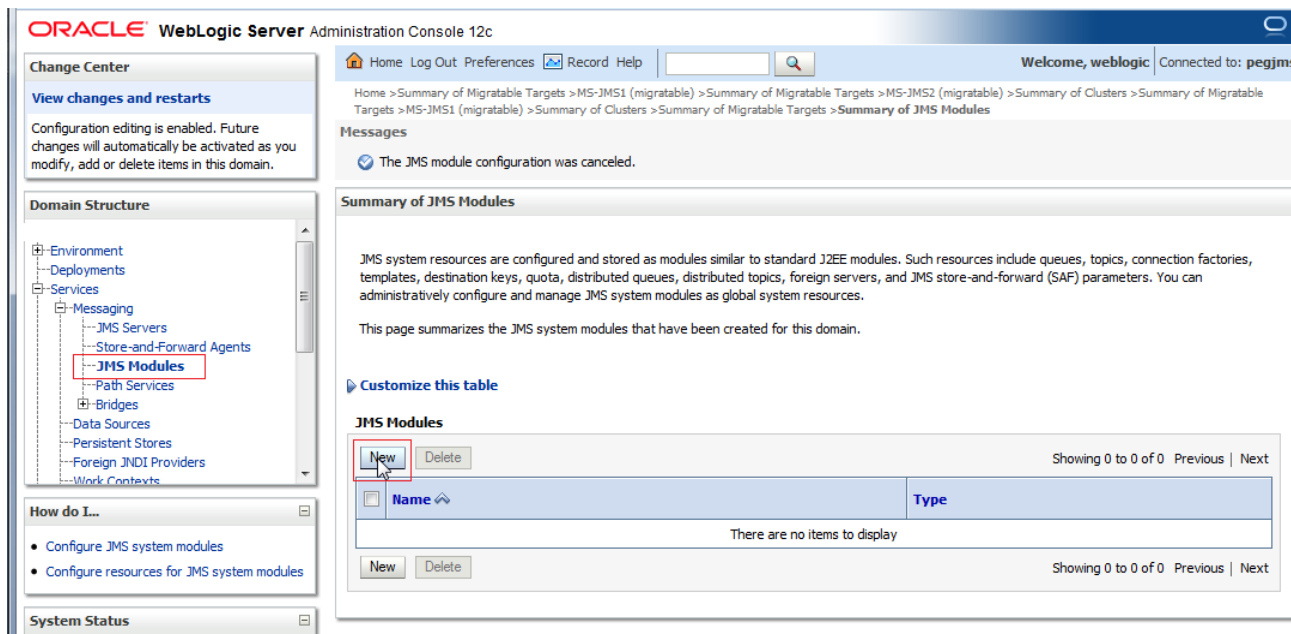

- 2) Enter name as JMS\_MODULE and Click on **Next**

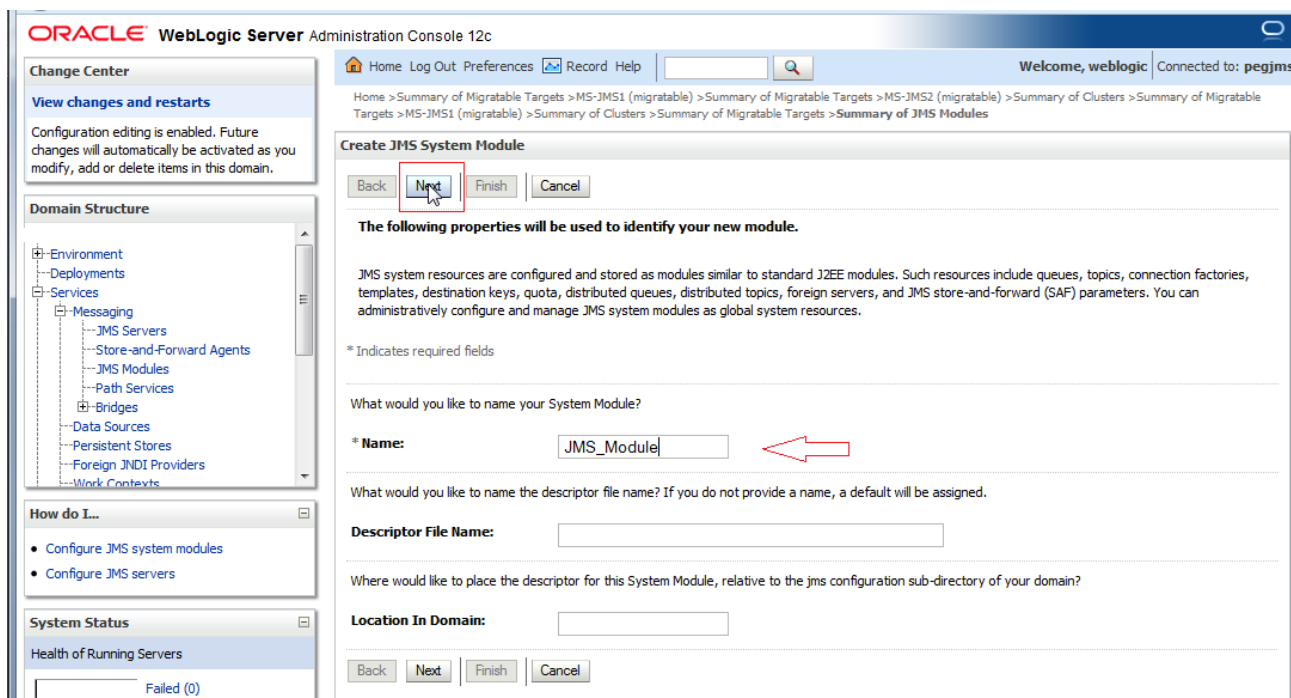

- 3) Select Target as Cluster-JMS and Click on **Next**

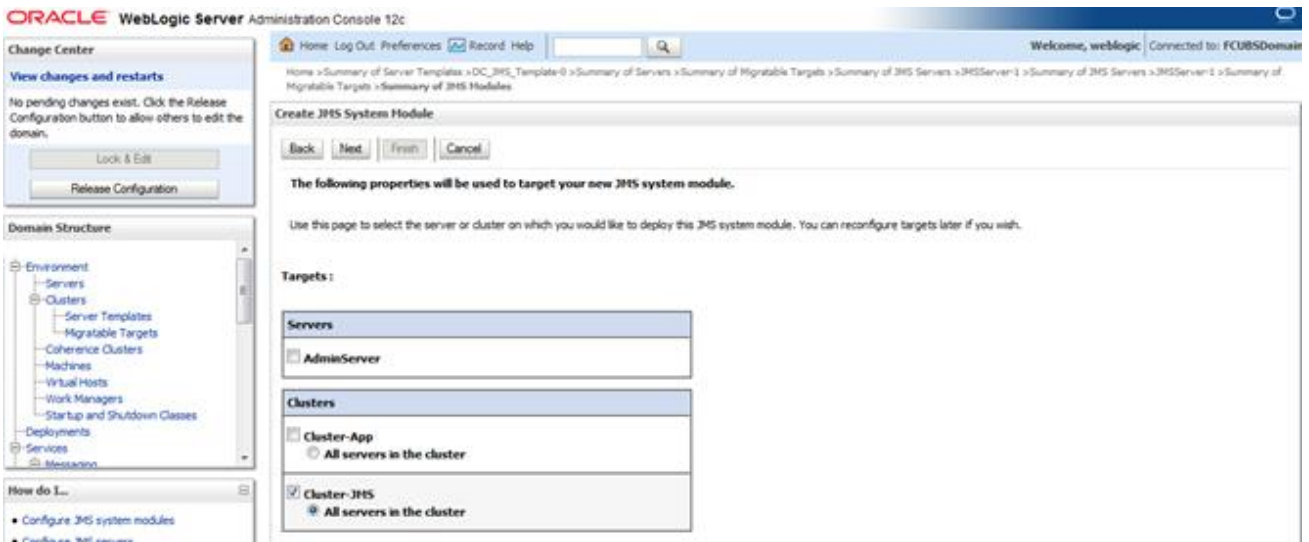

4) Select the checkbox and Click on **Finish**

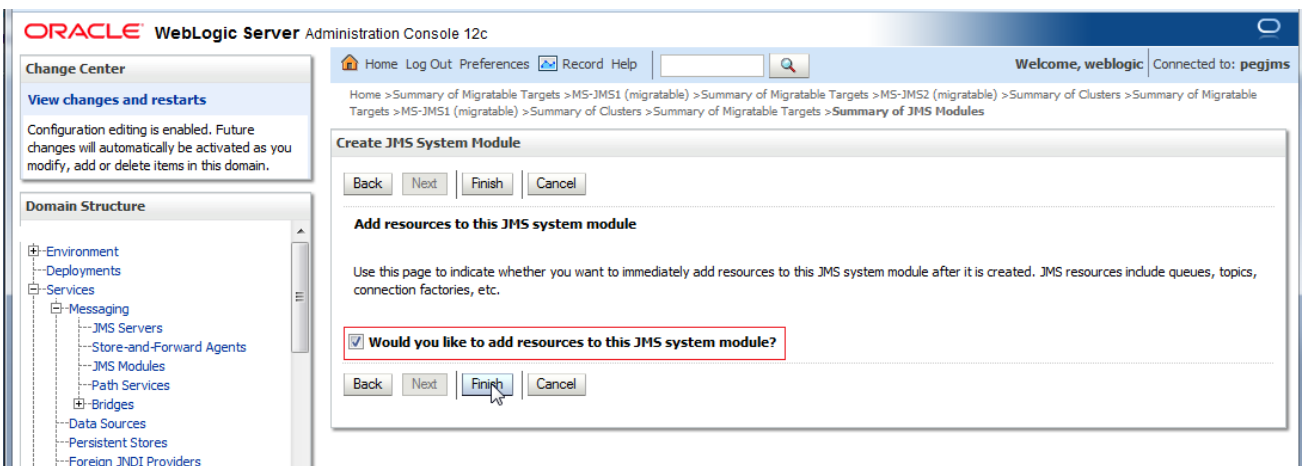

5) JMS\_MODULE is created

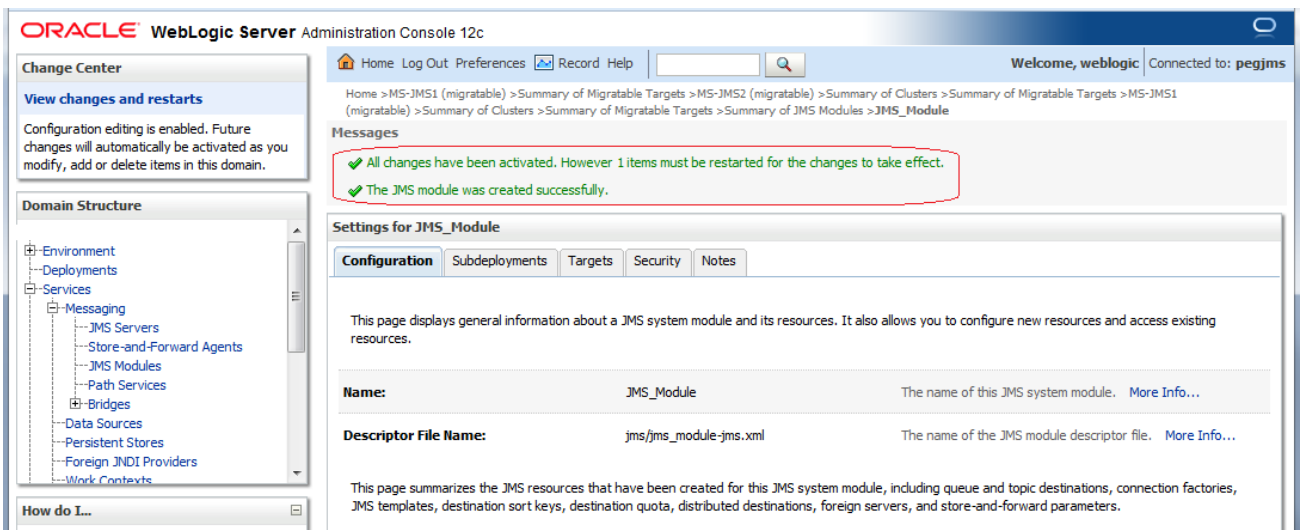

## 4.2 Sub Deployment Creation

- 1) In JMS\_MODULE, Click on Sub Deployment tab , Click on **New**

The screenshot shows the Oracle WebLogic Server Administration Console. The left sidebar contains the 'Domain Structure' tree with 'JMS Modules' highlighted. The main content area is titled 'Settings for JMS\_Module' and has several tabs: 'Configuration', 'Subdeployments', 'Targets', 'Security', and 'Notes'. The 'Subdeployments' tab is selected and highlighted with a red box. Below the tabs, there is a 'Summary of Resources' section with a table. The table has columns for 'Name', 'Type', 'JNDI Name', 'Subdeployment', and 'Targets'. The table is currently empty, and a red arrow points to the 'New' button located below the table.

- 2) Enter name as JMS\_SUB and click on **Next**

The screenshot shows the 'Create a New Subdeployment' page in the Oracle WebLogic Server Administration Console. The page has a 'Subdeployment Properties' section. The 'Subdeployment Name' field is filled with the text 'JMS\_SUB'. A red arrow points to the 'Next' button, which is also highlighted with a red box. The 'Back', 'Finish', and 'Cancel' buttons are also visible.

### 3) Select Target as Cluster-JMS and Click on **Finish**

The screenshot shows the 'Create a New Subdeployment' wizard in the Oracle WebLogic Server Administration Console. The breadcrumb path is: Home > DC\_JMS\_Template-0 > Summary of Servers > Summary of Migratable Targets > Summary of JMS Servers > JMSServer-1 > Summary of Migratable Targets > Summary of JMS Modules > JMS\_MODULE. The wizard has three steps: 'Servers', 'Clusters', and 'JMS Servers'. In the 'Clusters' step, 'Cluster-JMS' is selected with a radio button, and 'All servers in the cluster' is chosen. The 'JMS Servers' step shows 'JMSServer-1' as an option. Navigation buttons 'Back', 'Next', 'Finish', and 'Cancel' are visible at the top and bottom of the wizard.

### 4) Sub-Deployment is created

The screenshot shows the 'Settings for JMS\_Module' page in the Oracle WebLogic Server Administration Console. The breadcrumb path is: Home > MS-JMS1 (migratable) > Summary of Migratable Targets > MS-JMS2 (migratable) > Summary of Clusters > Summary of Migratable Targets > MS-JMS1 (migratable) > Summary of Clusters > Summary of Migratable Targets > Summary of JMS Modules > JMS\_Module. A message box at the top states: 'All changes have been activated. However 1 items must be restarted for the changes to take effect.' and 'Subdeployment created successfully.' Below this, the 'Subdeployments' section shows a table with one entry:

Name	Resources	Targets
JMS_SUB		Cluster-JMS

The 'How do I...' sidebar on the left has a red arrow pointing to the 'Configure subdeployments in JMS system modules' link.



## 4.3 Resource Creation

### 4.3.1 Queue Creation

1) In JMS\_MODULE Click on **New**

The screenshot shows the Oracle WebLogic Server Administration Console. The left sidebar contains the 'Domain Structure' tree with 'JMS Modules' highlighted. The main content area is titled 'Settings for JMS\_Module' and has several tabs: 'Configuration', 'Subdeployments', 'Targets', 'Security', and 'Notes'. The 'Configuration' tab is active, displaying general information about the JMS system module. Below this information is a 'Summary of Resources' section with 'New' and 'Delete' buttons. The 'New' button is highlighted with a red box.

2) Select Distributed Queue and Click on **Next**

The screenshot shows the 'Create a New JMS System Module Resource' page. At the top, there are 'Back', 'Next', 'Finish', and 'Cancel' buttons. The 'Next' button is highlighted with a red box. Below the buttons, the page asks to 'Choose the type of resource you want to create.' and provides three options: 'Connection Factory', 'Queue', and 'Distributed Queue'. The 'Distributed Queue' option is selected, indicated by a red arrow pointing to its radio button. The 'Distributed Queue' description states: 'Defines a set of queues that are distributed on multiple JMS servers, but which are accessible as a single, logical queue to JMS clients. More Info...'

3) Enter the queue name and Click on **Next**.

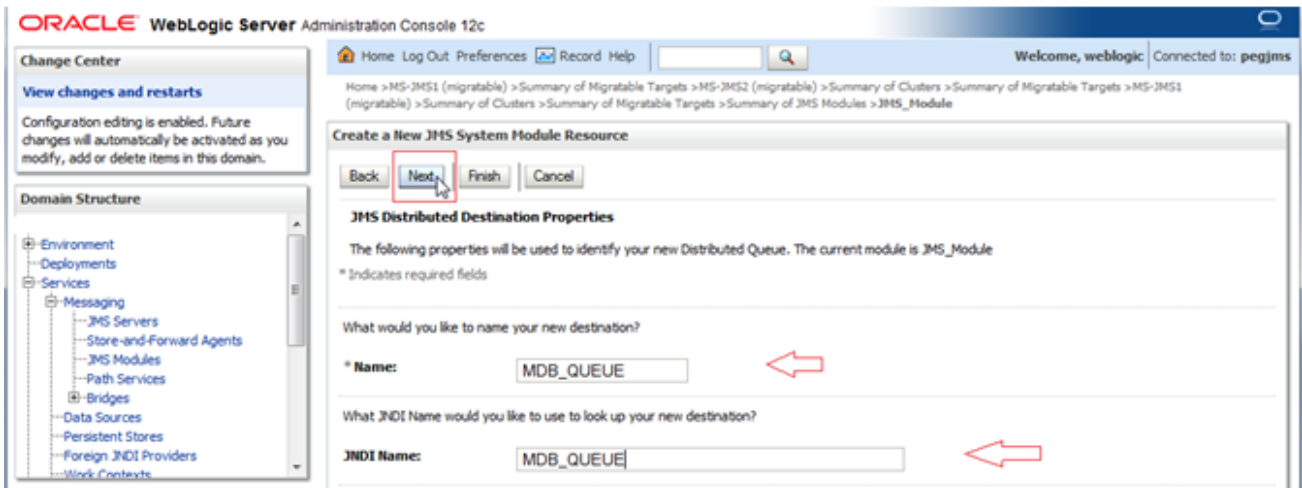

4) Click on **Advanced Targeting**.

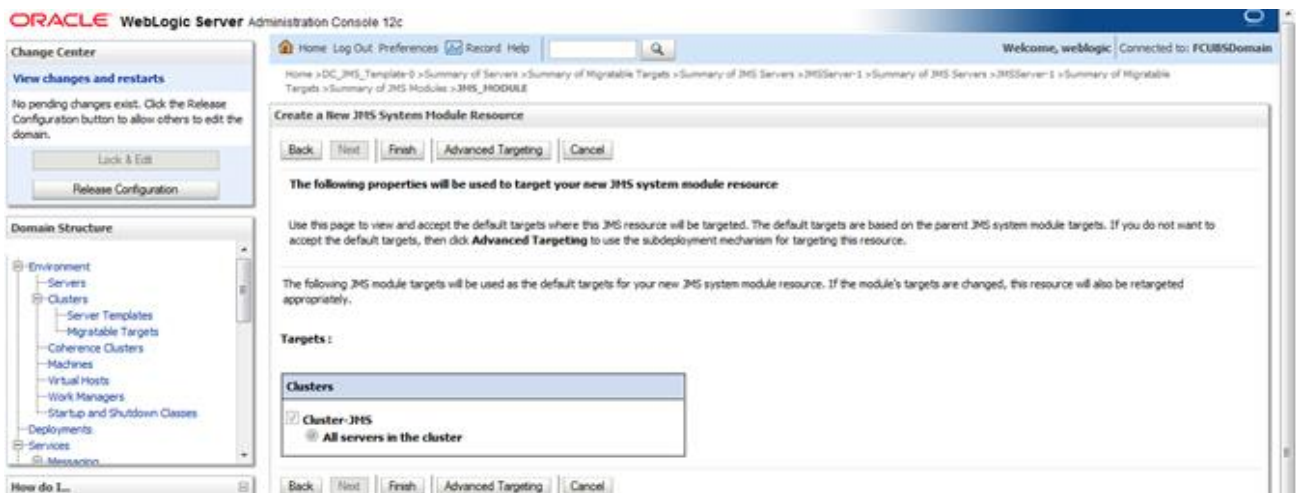

5) Select Subdeployment as JMS\_SUB and Click on **Finish**.

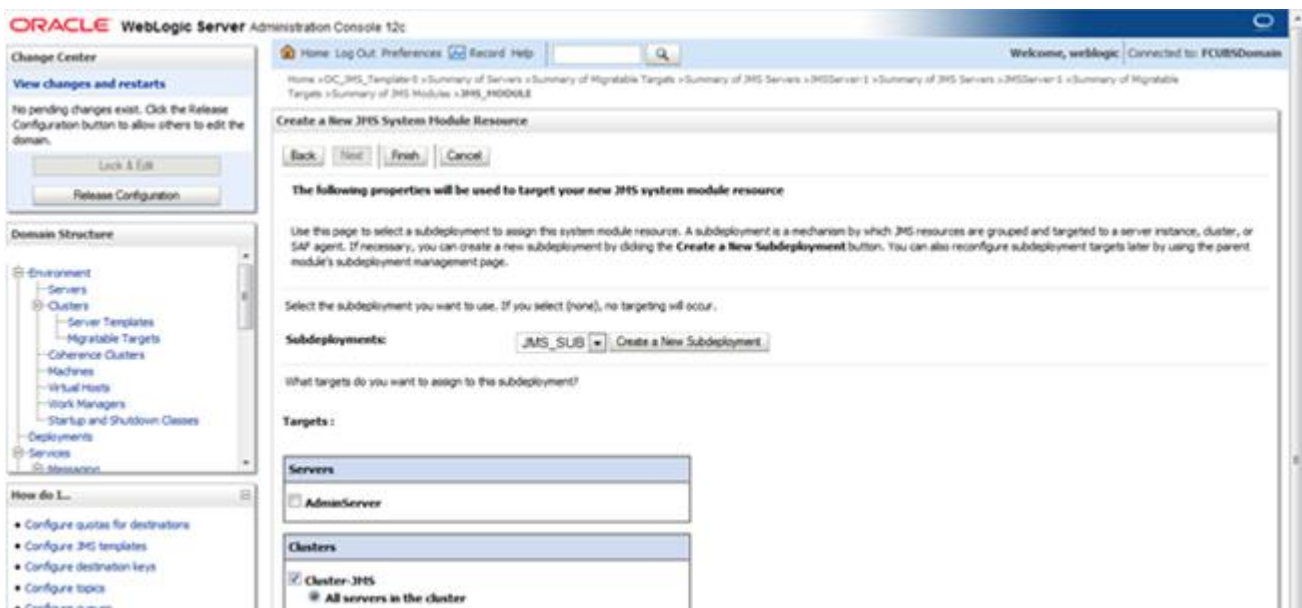

## 6) MDB\_QUEUE is created

ORACLE WebLogic Server Administration Console 12c

Home > MS-JMS1 (migratable) > Summary of Migratable Targets > MS-JMS2 (migratable) > Summary of Clusters > Summary of Migratable Targets > MS-JMS1 (migratable) > Summary of Clusters > Summary of Migratable Targets > Summary of JMS Modules > JMS\_Module

Messages

- ✓ All changes have been activated. However 1 items must be restarted for the changes to take effect.
- ✓ The JMS distributed queue was created successfully.

Settings for JMS\_Module

Configuration Subdeployments Targets Security Notes

This page displays general information about a JMS system module and its resources. It also allows you to configure new resources and access existing resources.

**Name:** JMS\_Module The name of this JMS system module. [More Info...](#)

**Descriptor File Name:** jms/jms\_module-jms.xml The name of the JMS module descriptor file. [More Info...](#)

This page summarizes the JMS resources that have been created for this JMS system module, including queue and topic destinations, connection factories, JMS templates, destination sort keys, destination quota, distributed destinations, foreign servers, and store-and-forward parameters.

Customize this table

Summary of Resources

New Delete Showing 1 to 1 of 1 Previous | Next

Name	Type	JNDI Name	Subdeployment	Targets
MDB_QUEUE	Uniform Distributed Queue	MDB_QUEUE	JMS_SUB	Cluster-JMS

New Delete Showing 1 to 1 of 1 Previous | Next

## 7) Similarly Create MDB\_QUEUE\_RESPONSE and MDB\_QUEUE\_DLQ

ORACLE WebLogic Server Administration Console 12c

Home > DC\_JMS\_Template-0 > Summary of Servers > Summary of Migratable Targets > Summary of JMS Servers > JMSServer-1 > Summary of JMS Servers > JMSServer-1 > Summary of Migratable Targets > Summary of JMS Modules > JMS\_MODULE

Messages

- ✓ All changes have been activated. No restarts are necessary.

Settings for JMS\_MODULE

Configuration Subdeployments Targets Security Notes

This page displays general information about a JMS system module and its resources. It also allows you to configure new resources and access existing resources.

**Name:** JMS\_MODULE The name of this JMS system module. [More Info...](#)

**Descriptor File Name:** jms/jms\_module-jms.xml The name of the JMS module descriptor file. [More Info...](#)

This page summarizes the JMS resources that have been created for this JMS system module, including queue and topic destinations, connection factories, JMS templates, destination sort keys, destination quota, distributed destinations, foreign servers, and store-and-forward parameters.

Customize this table

Summary of Resources

Click the **Lock & Edit** button in the Change Center to activate all the buttons on this page.

New Delete Showing 1 to 3 of 3 Previous | Next

Name	Type	JNDI Name	Subdeployment	Targets
MDB_QUEUE	Uniform Distributed Queue	MDB_QUEUE	JMS_SUB	Cluster-JMS
MDB_QUEUE_DLQ	Uniform Distributed Queue	MDB_QUEUE_DLQ	JMS_SUB	Cluster-JMS
MDB_QUEUE_RESPONSE	Uniform Distributed Queue	MDB_QUEUE_RESPONSE	JMS_SUB	Cluster-JMS

New Delete Showing 1 to 3 of 3 Previous | Next

## 4.3.2 Connection Factory Creation

1) In JMS\_MODULE, Click on **New**

ORACLE WebLogic Server Administration Console 12c

Home > MS-JMS1 (migratable) > Summary of Migratable Targets > MS-JMS2 (migratable) > Summary of Clusters > Summary of Migratable Targets > MS-JMS1 (migratable) > Summary of Clusters > Summary of Migratable Targets > Summary of JMS Modules > JMS\_Module

Messages

- ✓ All changes have been activated. However 1 items must be restarted for the changes to take effect.
- ✓ The JMS distributed queue was created successfully.

Settings for JMS\_Module

**Configuration** Subdeployments Targets Security Notes

This page displays general information about a JMS system module and its resources. It also allows you to configure new resources and access existing resources.

**Name:** JMS\_Module The name of this JMS system module. [More Info...](#)

**Descriptor File Name:** jms/jms\_module-jms.xml The name of the JMS module descriptor file. [More Info...](#)

This page summarizes the JMS resources that have been created for this JMS system module, including queue and topic destinations, connection factories, JMS templates, destination sort keys, destination quota, distributed destinations, foreign servers, and store-and-forward parameters.

Customize this table

Summary of Resources

New Delete Showing 1 to 3 of 3 Previous | Next

Name	Type	JNDI Name	Subdeployment	Targets
MDB_QUEUE	Uniform Distributed Queue	MDB_QUEUE	JMS_SUB	Cluster-JMS
MDB_QUEUE_DLQ	Uniform Distributed Queue	MDB_QUEUE_DLQ	JMS_SUB	Cluster-JMS
MDB_QUEUE_RESPONSE	Uniform Distributed Queue	MDB_QUEUE_RESPONSE	JMS_SUB	Cluster-JMS

New Delete Showing 1 to 3 of 3 Previous | Next

WebLogic Server Version: 12.1.3.0.0  
Copyright (c) 1996,2014, Oracle and/or its affiliates. All rights reserved.  
Oracle is a registered trademark of Oracle Corporation and/or its affiliates. Other names may be trademarks of their respective owners.

2) Select Connection Factory and click on **Next**

ORACLE WebLogic Server Administration Console 12c

Home > MS-JMS1 (migratable) > Summary of Migratable Targets > MS-JMS2 (migratable) > Summary of Clusters > Summary of Migratable Targets > MS-JMS1 (migratable) > Summary of Clusters > Summary of Migratable Targets > Summary of JMS Modules > JMS\_Module

Create a New JMS System Module Resource

Back **Next** Finish Cancel

Choose the type of resource you want to create.

Use these pages to create resources in a JMS system module, such as queues, topics, templates, and connection factories.

Depending on the type of resource you select, you are prompted to enter basic information for creating the resource. For targetable resources, like stand-alone queues and topics, connection factories, distributed queues and topics, foreign servers, and JMS SAF destinations, you can also proceed to targeting pages for selecting appropriate server targets. You can also associate targetable resources with subdeployments, which is an advanced mechanism for grouping JMS module resources and the members to server resources.

**Connection Factory** Defines a set of connection configuration parameters that are used to create connections for JMS clients. [More Info...](#)

Queue Defines a point-to-point destination type, which are used for asynchronous peer communications. A message

### 3) Enter the Name and Click on **Next**

ORACLE WebLogic Server Administration Console 12c

Home Log Out Preferences Record Help Welcome, weblogic Connected to: pegjms

Home > MS-JMS1 (migratable) > Summary of Migratable Targets > MS-JMS2 (migratable) > Summary of Clusters > Summary of Migratable Targets > MS-JMS1 (migratable) > Summary of Clusters > Summary of Migratable Targets > Summary of JMS Modules > JMS\_Module

#### Create a New JMS System Module Resource

Back Next Finish Cancel

#### Connection Factory Properties

The following properties will be used to identify your new connection factory. The current module is JMS\_Module.

\* Indicates required fields

What would you like to name your new connection factory?

\* Name:  ←

What JNDI Name would you like to use to look up your new connection factory?

JNDI Name:  ←

### 4) Click on **Advance Targeting**

ORACLE WebLogic Server Administration Console 12c

Home Log Out Preferences Record Help Welcome, weblogic Connected to: FCUBSDomain

Home > DC\_JMS\_Template-0 > Summary of Servers > Summary of Migratable Targets > Summary of JMS Servers > JMSServer-1 > Summary of JMS Servers > JMSServer-1 > Summary of Migratable Targets > Summary of JMS Modules > JMS\_MODULE

#### Create a New JMS System Module Resource

Back Next Finish Advanced Targeting Cancel

#### The following properties will be used to target your new JMS system module resource

Use this page to view and accept the default targets where this JMS resource will be targeted. The default targets are based on the parent JMS system module targets. If you do not want to accept the default targets, then click **Advanced Targeting** to use the subdeployment mechanism for targeting this resource.

The following JMS module targets will be used as the default targets for your new JMS system module resource. If the module's targets are changed, this resource will also be retargeted appropriately.

Targets:

Clusters
<input checked="" type="checkbox"/> Cluster-JMS
<input type="radio"/> All servers in the cluster

Back Next Finish Advanced Targeting Cancel

## 5) Select JMS\_SUB and Click on Finish

**ORACLE WebLogic Server Administration Console 12c**

Home Log Out Preferences Record Help Welcome, weblogic Connected to: FCUBSDomain

Home > DC\_JMS\_Template-0 > Summary of Servers > Summary of Migratable Targets > Summary of JMS Servers > JMSServer-1 > Summary of Migratable Targets > Summary of JMS Modules > JMS\_MODULE

### Create a New JMS System Module Resource

Back Next Finish Cancel

The following properties will be used to target your new JMS system module resource

Use this page to select a subdeployment to assign this system module resource. A subdeployment is a mechanism by which JMS resources are grouped and targeted to a server instance, cluster, or SAF agent. If necessary, you can create a new subdeployment by clicking the **Create a New Subdeployment** button. You can also reconfigure subdeployment targets later by using the parent module's subdeployment management page.

Select the subdeployment you want to use. If you select (none), no targeting will occur.

**Subdeployments:** JMS\_SUB Create a New Subdeployment

What targets do you want to assign to this subdeployment?

**Targets :**

**Servers**

AdminServer

**Clusters**

Cluster-JMS

All servers in the cluster

**JMS Servers**

JMSServer-1

Back Next Finish Cancel

**Change Center**

**View changes and restarts**

No pending changes exist. Click the Release Configuration button to allow others to edit the domain.

Lock & Edit

Release Configuration

**Domain Structure**

- Environment
  - Servers
    - Clusters
      - Server Templates
      - Migratable Targets
    - Coherence Clusters
    - Machines
    - Virtual Hosts
    - Work Managers
    - Startup and Shutdown Classes
  - Deployments
    - Services
    - Messaging

**How do I...**

- Configure quotas for destinations
- Configure JMS templates
- Configure destination keys
- Configure topics
- Configure queues
- Configure connection factories
- Configure uniform distributed topics
- Configure uniform distributed queues
- Configure foreign servers
- Configure JMS SAF

**System Status**

## 6) Connection Factory is Created.

**ORACLE WebLogic Server Administration Console 12c**

Home Log Out Preferences Record Help   Welcome, weblogic Connected to: pegjms

Home > MS-JMS1 (migratable) > Summary of Migratable Targets > MS-JMS2 (migratable) > Summary of Clusters > Summary of Migratable Targets > MS-JMS1 (migratable) > Summary of Clusters > Summary of Migratable Targets > Summary of JMS Modules > JMS\_Module

**Messages**

All changes have been activated. However 1 items must be restarted for the changes to take effect.  
 Connection factory created successfully.

**Settings for JMS\_Module**

Configuration Subdeployments Targets Security Notes

This page displays general information about a JMS system module and its resources. It also allows you to configure new resources and access existing resources.

**Name:** JMS\_Module The name of this JMS system module. [More Info...](#)

**Descriptor File Name:** jms/jms\_module-jms.xml The name of the JMS module descriptor file. [More Info...](#)

This page summarizes the JMS resources that have been created for this JMS system module, including queue and topic destinations, connection factories, JMS templates, destination sort keys, destination quota, distributed destinations, foreign servers, and store-and-forward parameters.

[Customize this table](#)

**Summary of Resources**

Showing 1 to 4 of 4 Previous | Next

<input type="checkbox"/>	Name ↕	Type	JNDI Name	Subdeployment	Targets
<input type="checkbox"/>	MDBQCF ←	Connection Factory	MDBQCF	JMS_SUB	Cluster-JMS
<input type="checkbox"/>	MDB_QUEUE	Uniform Distributed Queue	MDB_QUEUE	JMS_SUB	Cluster-JMS
<input type="checkbox"/>	MDB_QUEUE_DLQ	Uniform Distributed Queue	MDB_QUEUE_DLQ	JMS_SUB	Cluster-JMS
<input type="checkbox"/>	MDB_QUEUE_RESPONSE	Uniform Distributed Queue	MDB_QUEUE_RESPONSE	JMS_SUB	Cluster-JMS

Showing 1 to 4 of 4 Previous | Next

**Change Center**  
View changes and restarts  
Configuration editing is enabled. Future changes will automatically be activated as you modify, add or delete items in this domain.

**Domain Structure**

- Environment
- Deployments
- Services
  - Messaging
    - JMS Servers
    - Store-and-Forward Agents
    - JMS Modules
    - Path Services
  - Bridges
  - Data Sources
  - Persistent Stores
  - Foreign JNDI Providers
  - Work Contexts

**How do I...**  
No task help found.

**System Status**  
Health of Running Servers

- Failed (0)
- Critical (0)
- Overloaded (0)
- Warning (0)
- OK (1)

# 5. Server Restart

1) Increase the heap size of both DC\_JMS\_1 and DC\_JMS\_2 cluster

**Summary of Servers**

A server is an instance of WebLogic Server that runs in its own Java Virtual Machine (JVM) and has its own configuration. This page summarizes each server that has been configured in the current WebLogic Server domain.

**Servers (Filtered - More Columns Exist)**

Click the **Lock & Edit** button in the Change Center to activate all the buttons on this page.

Name	Type	Cluster	Machine	State	Health	Listen Port
AdminServer(admin)	Configured			RUNNING	OK	7001
DC_FCUBS_1	Dynamic	Cluster-App	MAC-1	SHUTDOWN	Not reachable	7101
DC_FCUBS_2	Dynamic	Cluster-App	MAC-2	SHUTDOWN	Not reachable	7102
DC_FCUBS_3	Dynamic	Cluster-App	MAC-1	SHUTDOWN	Not reachable	7103
DC_FCUBS_4	Dynamic	Cluster-App	MAC-2	SHUTDOWN	Not reachable	7104
DC_JMS_1	Dynamic	Cluster-JMS	MAC-1	SHUTDOWN	Not reachable	7106
DC_JMS_2	Dynamic	Cluster-JMS	MAC-2	SHUTDOWN	Not reachable	7107

2) Select the cluster 'DC\_JMS\_Template-0' and

**Summary of Server Templates**

This page summarizes each server template that has been configured in the current WebLogic Server domain. A server template contains common, non-default attributes that you can apply to a set of server instances, which then inherit the template configuration. Server templates enable you to easily manage configuration for a group of server instances in one centralized location.

**Server Templates**

Click the **Lock & Edit** button in the Change Center to activate all the buttons on this page.

Name	Cluster	Machine	Listen Port	Listen Address
DC_FCUBS_Template	Cluster-App		7100	
DC_JMS_Template-0	Cluster-JMS		7105	



3) Click on Server Start Tab and in Arguments Section enter `-XX:MaxPermSize=512m`

The screenshot displays the Oracle WebLogic Server Administration Console interface. The main content area is titled "Settings for DC\_JMS\_Template-0" and features a "Server Start" tab. Below the tabs, there are several configuration fields: "Java Home", "Java Vendor", "BEA Home", "Root Directory", "Class Path", and "Arguments". The "Arguments" field is highlighted with a red box and contains the text `-XX:MaxPermSize=512m`. The left sidebar contains navigation panels for "Change Center", "Domain Structure", "How do I...", and "System Status".

4) **Restart** the AdminServer and DC\_JMS\_1 and DC\_JMS\_2 managed servers.

## 6. Foreign Server Creation

### 6.1 Module Creation

#### 1) JMS\_Modules and Click on New

ORACLE WebLogic Server Administration Console 12c

Home > Summary of Servers > MS-JMS2 > Summary of Virtual Hosts > Summary of Servers > Summary of Clusters > Summary of Migratable Targets > Summary of Servers > Summary of Deployments > Summary of JMS Modules

**Summary of JMS Modules**

JMS system resources are configured and stored as modules similar to standard J2EE modules. Such resources include queues, topics, connection factories, templates, destination keys, quota, distributed queues, distributed topics, foreign servers, and JMS store-and-forward (SAF) parameters. You can administratively configure and manage JMS system modules as global system resources.

This page summarizes the JMS system modules that have been created for this domain.

Customize this table

Name	Type
JMS_Module	System

New Delete

Showing 1 to 1 of 1 Previous | Next

New Delete

Showing 1 to 1 of 1 Previous | Next

How do I...  
• Configure JMS system modules  
• Configure resources for JMS system modules

#### 2) Enter name as MDB\_MODULE and click on Next

ORACLE WebLogic Server Administration Console 12c

Home > Summary of Migratable Targets > MS-JMS1 (migratable) > Summary of Migratable Targets > MS-JMS2 (migratable) > Summary of Clusters > Summary of Migratable Targets > MS-JMS1 (migratable) > S

**Create JMS System Module**

Back Next Finish Cancel

The following properties will be used to identify your new module.

JMS system resources are configured and stored as modules similar to standard J2EE modules. Such resources include queues, topics, connection factories, templates, destination keys, quota, distributed queues, distributed topics, foreign servers, and JMS store-and-forward (SAF) parameters. You can administratively configure and manage JMS system modules as global system resources.

\* Indicates required fields

What would you like to name your System Module?

\* Name:  ←

What would you like to name the descriptor file name? If you do not provide a name, a default will be assigned.

Descriptor File Name:

Where would like to place the descriptor for this System Module, relative to the jms configuration sub-directory of your domain?

Location In Domain:

Back Next Finish Cancel

3) Select target as Cluster-App and click on **Next**

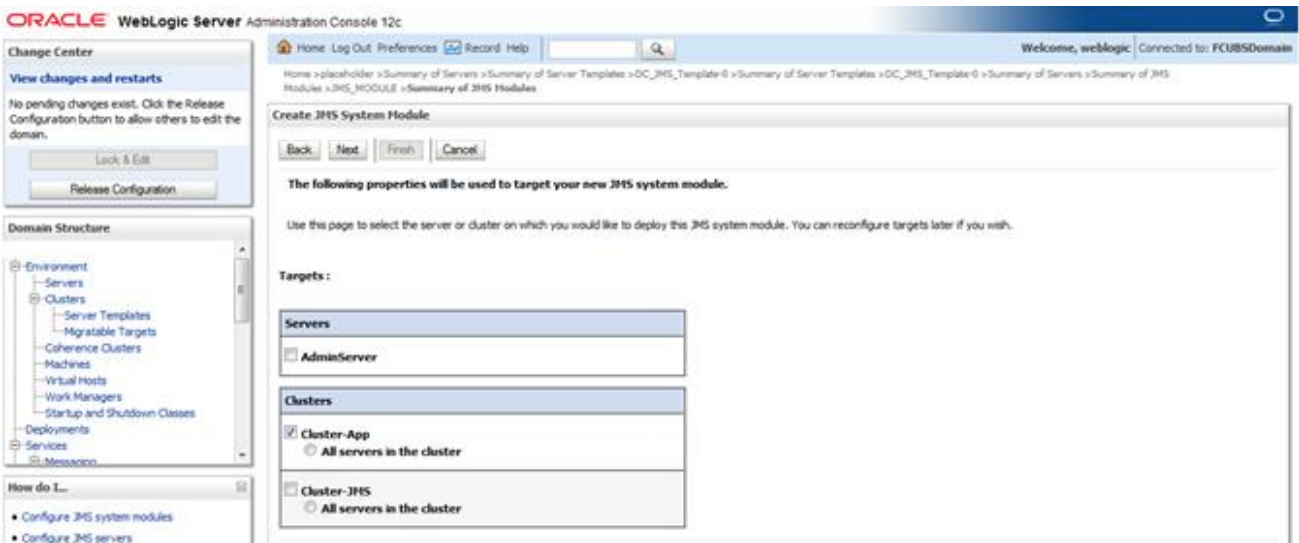

4) Select CheckBox and Click on **Finish**

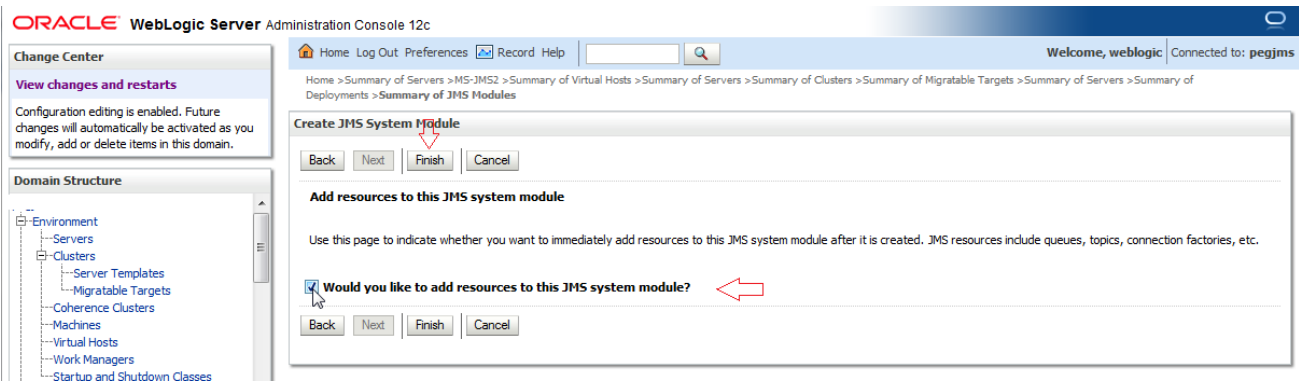

5) **MDB\_MODULE** is created

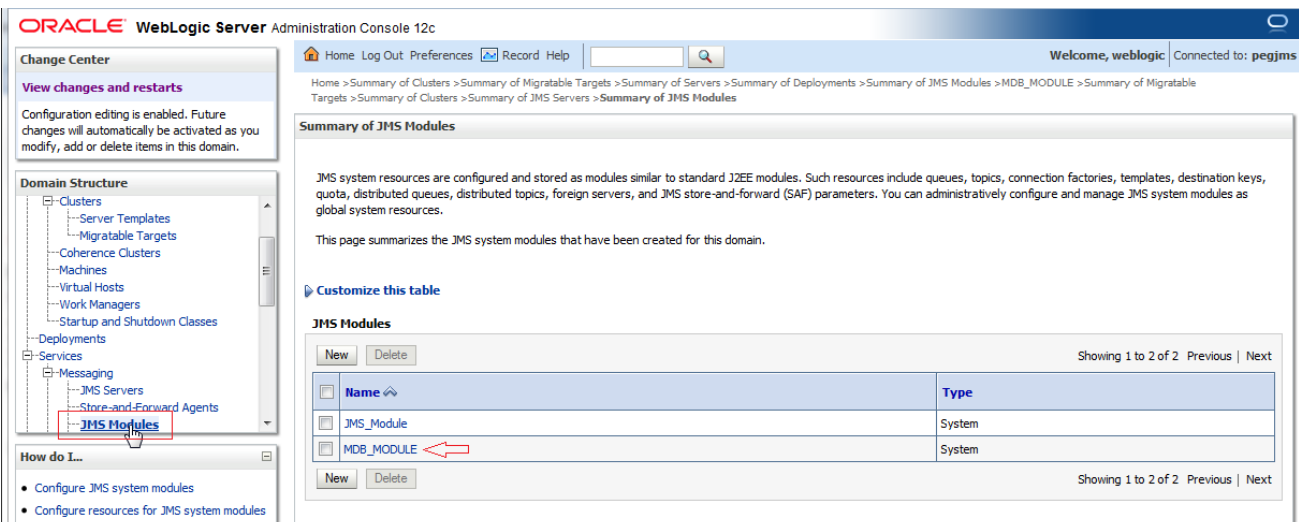

## 6.2 Foreign Server Creation

In MDB\_MODULE, Click on New Resource, Select Foreign Server

**Change Center**  
View changes and restarts  
Configuration editing is enabled. Future changes will automatically be activated as you modify, add or delete items in this domain.

**Domain Structure**

- Clusters
  - Server Templates
  - Migratable Targets
  - Coherence Clusters
  - Machines
  - Virtual Hosts
  - Work Managers
  - Startup and Shutdown Classes
- Deployments
- Services
  - Messaging
    - JMS Servers
    - Store-and-Forward Agents
    - JMS Modules**

**How do I...**

- Configure JMS system modules
- Configure resources for JMS system modules

**Summary of JMS Modules**

JMS system resources are configured and stored as modules similar to standard J2EE modules. Such resources include queues, topics, connection factories, templates, destination keys, quota, distributed queues, distributed topics, foreign servers, and JMS store-and-forward (SAF) parameters. You can administratively configure and manage JMS system modules as global system resources.

This page summarizes the JMS system modules that have been created for this domain.

Customize this table

**JMS Modules**

New Delete Showing 1 to 2 of 2 Previous | Next

Name	Type
JMS_Module	System
<b>MDB_MODULE</b>	System

New Delete Showing 1 to 2 of 2 Previous | Next

1) Click on Configuration → New

**ORACLE WebLogic Server Administration Console 12c**

Home > Summary of Deployments > Summary of JMS Modules > MDB\_MODULE > Summary of Migratable Targets > Summary of Clusters > Summary of JMS Servers > Summary of JMS Modules > MDB\_MODULE

**Settings for MDB\_MODULE**

Configuration Subdeployments Targets Security Notes

This page displays general information about a JMS system module and its resources. It also allows you to configure new resources and access existing resources.

**Name:** MDB\_MODULE The name of this JMS system module. [More Info...](#)

**Descriptor File Name:** jms/mdb\_module-jms.xml The name of the JMS module descriptor file. [More Info...](#)

This page summarizes the JMS resources that have been created for this JMS system module, including queue and topic destinations, connection factories, JMS templates, destination sort keys, destination quota, distributed destinations, foreign servers, and store-and-forward parameters.

Customize this table

**Summary of Resources**

New Delete Showing 0 to 0 of 0 Previous | Next

Name	Type	JNDI Name	Subdeployment	Targets
There are no items to display				

New Delete Showing 0 to 0 of 0 Previous | Next

**System Status**

Health of Running Servers

- Failed (1)
- Critical (0)

## 2) Select Foreign Server and Click on Next

**ORACLE WebLogic Server Administration Console 12c**

Home Log Out Preferences Record Help Welcome, weblogic Connected to: pegjms

Home > Summary of Deployments > Summary of JMS Modules > MDB\_MODULE > Summary of Migratable Targets > Summary of Clusters > Summary of JMS Servers > Summary of JMS Modules > MDB\_MODULE > Summary of JMS Modules > MDB\_MODULE

### Create a New JMS System Module Resource

Back Next Finish Cancel

**Choose the type of resource you want to create.**

Use these pages to create resources in a JMS system module, such as queues, topics, templates, and connection factories.

Depending on the type of resource you select, you are prompted to enter basic information for creating the resource. For targetable resources, like stand-alone queues and topics, connection factories, distributed queues and topics, foreign servers, and JMS SAF destinations, you can also proceed to targeting pages for selecting appropriate server targets. You can also associate targetable resources with subdeployments, which is an advanced mechanism for grouping JMS module resources and the members to server resources.

- Connection Factory** Defines a set of connection configuration parameters that are used to create connections for JMS clients. [More Info...](#)
- Queue** Defines a point-to-point destination type, which are used for asynchronous peer communications. A message delivered to a queue is distributed to only one consumer. [More Info...](#)
- Topic** Defines a publish/subscribe destination type, which are used for asynchronous peer communications. A message delivered to a topic is distributed to all topic consumers. [More Info...](#)
- Distributed Queue** Defines a set of queues that are distributed on multiple JMS servers, but which are accessible as a single, logical queue to JMS clients. [More Info...](#)
- Distributed Topic** Defines a set of topics that are distributed on multiple JMS servers, but which are accessible as a single, logical topic to JMS clients. [More Info...](#)
- Foreign Server** Defines foreign messaging providers or remote WebLogic Server instances that are not part of the current domain. [More Info...](#)

System Status

## 3) Enter name and Click on Next

**ORACLE WebLogic Server Administration Console 12c**

Home Log Out Preferences Record Help Welcome, weblogic Connected to: pegjms

Home > Summary of Deployments > Summary of JMS Modules > MDB\_MODULE > Summary of Migratable Targets > Summary of Clusters > Summary of JMS Servers > Summary of JMS Modules > MDB\_MODULE > Summary of JMS Modules > MDB\_MODULE

### Create a New JMS System Module Resource

Back Next Finish Cancel

#### Foreign Server Properties

The following properties will be used to identify your new foreign server. The current module is MDB\_MODULE.

\* Indicates required fields

\* **Name:** ForeignServer-1

Back Next Finish Cancel

#### 4) Click on Advanced Targeting

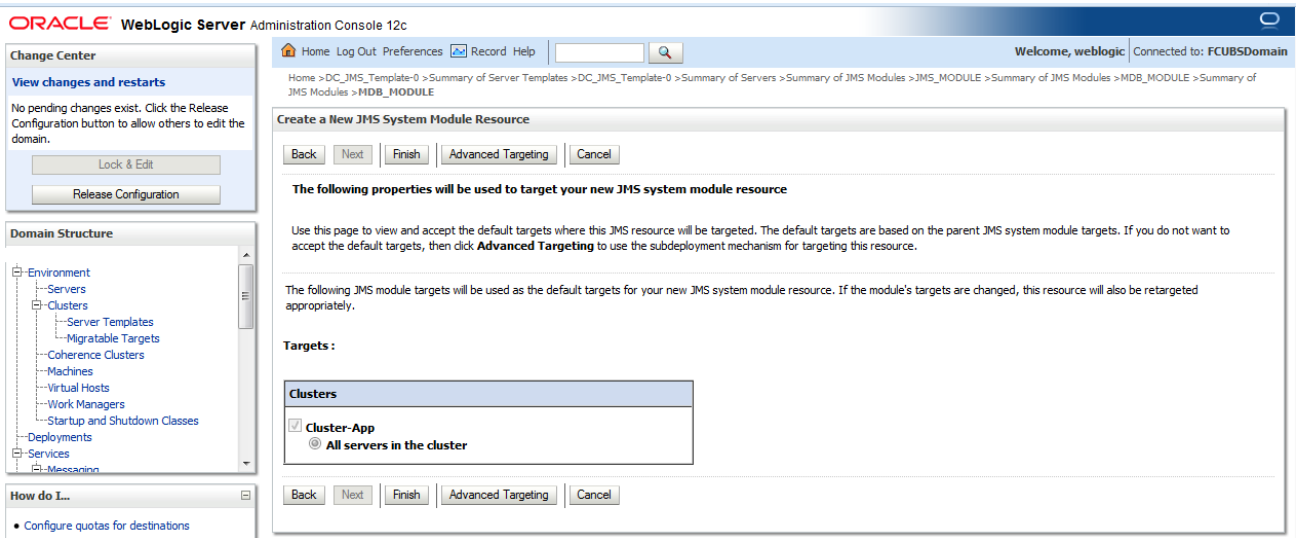

#### 5) Click on Create New SubDeployment

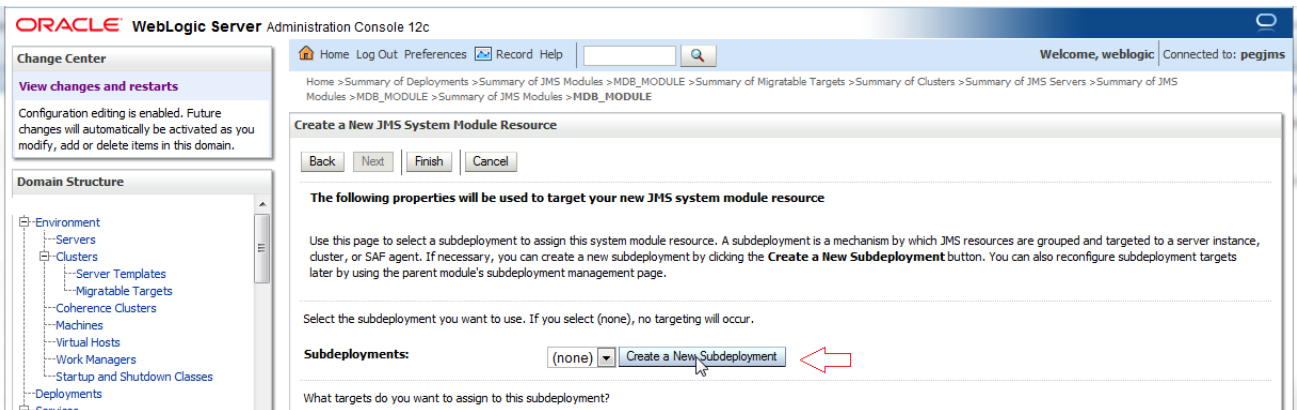

#### 6) Enter Name as MDB\_SUB and Click on OK

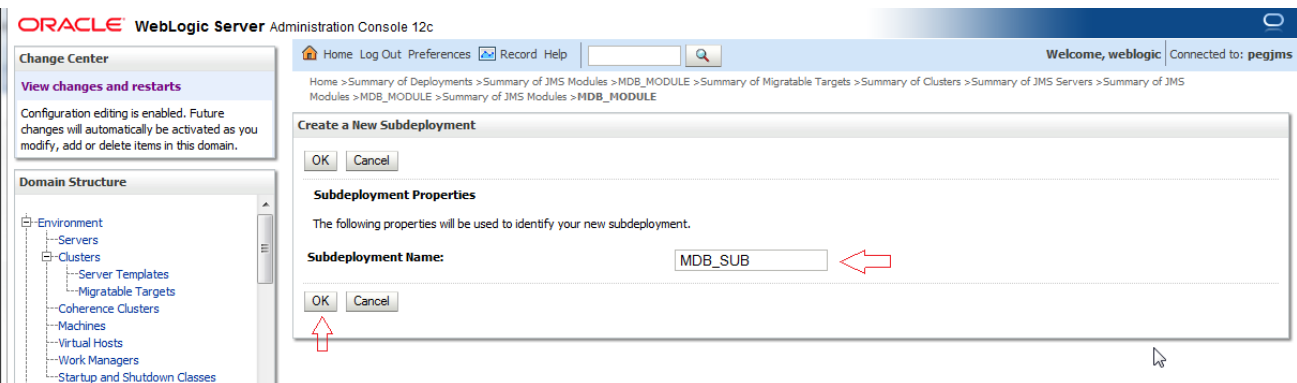

## 7) Select Target as Cluster-App and Click on Finish

**ORACLE WebLogic Server Administration Console 12c**

Home > DC\_JMS\_Template-0 > Summary of Server Templates > DC\_JMS\_Template-0 > Summary of Servers > Summary of JMS Modules > JMS\_MODULE > Summary of JMS Modules > MDB\_MODULE > Summary of JMS Modules > MDB\_MODULE

### Create a New JMS System Module Resource

Back Next Finish Cancel

**The following properties will be used to target your new JMS system module resource**

Use this page to select a subdeployment to assign this system module resource. A subdeployment is a mechanism by which JMS resources are grouped and targeted to a server instance, cluster, or SAF agent. If necessary, you can create a new subdeployment by clicking the **Create a New Subdeployment** button. You can also reconfigure subdeployment targets later by using the parent module's subdeployment management page.

Select the subdeployment you want to use. If you select (none), no targeting will occur.

**Subdeployments:** MDB\_SUB Create a New Subdeployment

What targets do you want to assign to this subdeployment?

**Targets :**

**Servers**

AdminServer

**Clusters**

Cluster-App  
 All servers in the cluster

**JMS Servers**

JMSServer-1

Back Next Finish Cancel

## 8) Foreign Server is created

**ORACLE WebLogic Server Administration Console 12c**

Home > Summary of Deployments > Summary of JMS Modules > MDB\_MODULE > Summary of Migratable Targets > Summary of Clusters > Summary of JMS Servers > Summary of JMS Modules > MDB\_MODULE > Summary of JMS Modules > MDB\_MODULE

Messages

✔ All changes have been activated. No restarts are necessary.  
 ✔ The foreign server was created successfully.

### Settings for MDB\_MODULE

Configuration Subdeployments Targets Security Notes

This page displays general information about a JMS system module and its resources. It also allows you to configure new resources and access existing resources.

**Name:** MDB\_MODULE The name of this JMS system module. [More Info...](#)

**Descriptor File Name:** jms/mdb\_module-jms.xml The name of the JMS module descriptor file. [More Info...](#)

This page summarizes the JMS resources that have been created for this JMS system module, including queue and topic destinations, connection factories, JMS templates, destination sort keys, destination quota, distributed destinations, foreign servers, and store-and-forward parameters.

[Customize this table](#)

**Summary of Resources**

New Delete Showing 1 to 1 of 1 Previous | Next

Name	Type	JNDI Name	Subdeployment	Targets
<input type="checkbox"/> ForeignServer-1	Foreign Server	N/A	MDB_SUB	Cluster-App

New Delete Showing 1 to 1 of 1 Previous | Next

## 6.3 Foreign Server Configuration

1) Click on ForeignServer-1

The screenshot shows the Oracle WebLogic Server Administration Console. The left sidebar contains navigation menus for Change Center, Domain Structure, How do I..., and System Status. The main content area displays the 'Settings for MDB\_MODULE' page. The 'Configuration' tab is active, showing general information about the JMS system module. Below this, a 'Summary of Resources' table lists the configured resources. A red arrow points to the 'ForeignServer-1' entry in this table.

Name	Type	JNDI Name	Subdeployment	Targets
ForeignServer-1	Foreign Server	N/A	MDB_SUB	Cluster-App

2) Enter the JNDI URL as Cluster URL(JMS Managed Servers) and Click on Save

The screenshot shows the Oracle WebLogic Server Administration Console. The left sidebar contains navigation menus for Change Center, Domain Structure, How do I..., and System Status. The main content area displays the 'Settings for ForeignServer-1' page. The 'Configuration' tab is active, showing the 'General' sub-tab. The 'JNDI Connection URL' field is filled with 't3://10.184.148.185:7106,10.184.148.189:7107'. The 'Save' button is visible at the top of the configuration area.



### 3) Click on Connection Factories

The screenshot shows the Oracle WebLogic Server Administration Console. The left sidebar contains the 'Change Center' and 'Domain Structure' tree. The main content area is titled 'Settings for ForeignServer-1' and has three tabs: 'Configuration', 'Subdeployment', and 'Notes'. The 'Configuration' tab is active, and the 'Connection Factories' sub-tab is selected. A red arrow points to the 'New' button above a table. The table is titled 'Foreign Connection Factories (Filtered - More Columns Exist)' and is currently empty, displaying 'Showing 0 to 0 of 0' items. The table has columns for 'Name', 'Local JNDI Name', and 'Remote JNDI Name'.

### 4) Create MDBQCF Connection Factory

The screenshot shows the 'Create a New Foreign JMS Connection Factory' dialog box. The 'Name' field is set to 'MDBQCF'. The 'Local JNDI Name' field is also set to 'MDBQCF', with a red arrow pointing to it. The 'Remote JNDI Name' field is set to 'MDBQCF', also with a red arrow pointing to it. The dialog has 'OK' and 'Cancel' buttons. The background shows the 'Settings for ForeignServer-1' configuration page with the 'New' button highlighted from the previous step.

### 5) Click on Destination

The screenshot shows the Oracle WebLogic Server Administration Console. The left sidebar is the same as in the previous steps. The main content area is still 'Settings for ForeignServer-1', but the 'Destinations' sub-tab is now selected. A red arrow points to the 'Destinations' tab. Below the tabs, there is a message: 'All changes have been activated. However, 1 item must be restarted for the changes to take effect.' The 'Foreign Connection Factories' table now contains one entry: 'MDBQCF' in the 'Name' column, 'MDBQCF' in the 'Local JNDI Name' column, and 'MDBQCF' in the 'Remote JNDI Name' column. The table shows 'Showing 1 to 1 of 1' items.

## 6) Create MDB\_QUEUE

Home > JMS Modules > MDB\_MODULE > ForeignServer-1 > MDB\_MODULE > ForeignServer-1 > Summary of Servers > JMS Modules > MDB\_MODULE > ForeignServer-1 > Configuration

**Settings for ForeignServer-1**

Configuration | Subdeployment | Notes

General | **Destinations** | Connection Factories

A foreign destination (topic or queue) can be found on a remote server. When this destination is looked up on the local server, a look-up will be performed automatically on the remote JNDI directory, and the object will be returned from that directory.

This page summarizes the foreign destinations that have been created for this domain.

**Customize this table**

**Foreign Destinations**

Name	Local JNDI Name	Remote JNDI Name
There are no items to display		

Showing 0 to 0 of 0 Previous | Next

ORACLE WebLogic Server Administration Console 12c

Home | Log Out | Preferences | Record | Help

Welcome, weblogic | Connected to: pegjms

Home > MDB\_MODULE > Summary of Migratable Targets > Summary of Clusters > Summary of JMS Servers > Summary of JMS Modules > MDB\_MODULE > Summary of JMS Modules > MDB\_MODULE > ForeignServer-1 > Configuration

**Create a New Foreign JMS Destination**

OK | Cancel

**Foreign Destination Properties**

The following properties will be used to identify your new foreign destination.

\* Indicates required fields

\* **Name:**

**Local JNDI Name:**

**Remote JNDI Name:**

OK | Cancel

## 7) Similarly Create MDB\_QUEUE\_RESPONSE, MDB\_QUEUE\_DLQ

ORACLE WebLogic Server Administration Console 12c

Home | Log Out | Preferences | Record | Help

Welcome, weblogic | Connected to: pegjms

Home > MDB\_MODULE > Summary of Migratable Targets > Summary of Clusters > Summary of JMS Servers > Summary of JMS Modules > MDB\_MODULE > Summary of JMS Modules > MDB\_MODULE > ForeignServer-1 > Configuration

**Create a New Foreign JMS Destination**

OK | Cancel

**Foreign Destination Properties**

The following properties will be used to identify your new foreign destination.

\* Indicates required fields

\* **Name:**

**Local JNDI Name:**

**Remote JNDI Name:**

OK | Cancel

ORACLE WebLogic Server Administration Console 12c

Home Log Out Preferences Record Help Welcome, weblogic Connected to: pegjms

Home > MDB\_MODULE > Summary of Migratable Targets > Summary of Clusters > Summary of JMS Servers > Summary of JMS Modules > MDB\_MODULE > Summary of JMS Modules > MDB\_MODULE > ForeignServer-1 > Configuration

Messages  
All changes have been activated. However 1 items must be restarted for the changes to take effect.

Settings for ForeignServer-1  
Configuration Subdeployment Notes

General Destinations Connection Factories

A foreign destination (topic or queue) can be found on a remote server. When this destination is looked up on the local server, a look-up will be performed automatically on the remote JNDI directory, and the object will be returned from that directory.

This page summarizes the foreign destinations that have been created for this domain.

Customize this table

Foreign Destinations

Name ↕	Local JNDI Name	Remote JNDI Name
MDB_QUEUE	MDB_QUEUE	MDB_QUEUE
MDB_QUEUE_RESPONSE	MDB_QUEUE_RESPONSE	MDB_QUEUE_RESPONSE

Showing 1 to 2 of 2 Previous | Next

ORACLE WebLogic Server Administration Console 12c

Home Log Out Preferences Record Help Welcome, weblogic Connected to: pegjms

Home > MDB\_MODULE > Summary of Migratable Targets > Summary of Clusters > Summary of JMS Servers > Summary of JMS Modules > MDB\_MODULE > Summary of JMS Modules > MDB\_MODULE > ForeignServer-1 > Configuration

Create a New Foreign JMS Destination

OK Cancel

Foreign Destination Properties

The following properties will be used to identify your new foreign destination.

\* Indicates required fields

\* Name: MDB\_QUEUE\_DLQ

Local JNDI Name: MDB\_QUEUE\_DLQ

Remote JNDI Name: MDB\_QUEUE\_DLQ

OK Cancel

ORACLE WebLogic Server Administration Console 12c

Home Log Out Preferences Record Help Welcome, weblogic Connected to: pegjms

Home > MDB\_MODULE > Summary of Migratable Targets > Summary of Clusters > Summary of JMS Servers > Summary of JMS Modules > MDB\_MODULE > Summary of JMS Modules > MDB\_MODULE > ForeignServer-1 > Configuration

Messages  
All changes have been activated. However 1 items must be restarted for the changes to take effect.

Settings for ForeignServer-1  
Configuration Subdeployment Notes

General Destinations Connection Factories

A foreign destination (topic or queue) can be found on a remote server. When this destination is looked up on the local server, a look-up will be performed automatically on the remote JNDI directory, and the object will be returned from that directory.

This page summarizes the foreign destinations that have been created for this domain.

Customize this table

Foreign Destinations

Name ↕	Local JNDI Name	Remote JNDI Name
MDB_QUEUE	MDB_QUEUE	MDB_QUEUE
MDB_QUEUE_DLQ	MDB_QUEUE_DLQ	MDB_QUEUE_DLQ
MDB_QUEUE_RESPONSE	MDB_QUEUE_RESPONSE	MDB_QUEUE_RESPONSE

Showing 1 to 3 of 3 Previous | Next

8) After all the resources are created, **Restart** the Admin and Managed Servers.

# 7. Application Deployment

## 1) Deploy the EAR with Target as Cluster-App

The screenshot displays the Oracle WebLogic Administration Console interface. On the left, the 'Change Center' and 'Domain Structure' panels are visible. The main content area shows the 'Settings for GWMDB' page with the 'Targets' tab selected. Below the navigation tabs, there is a descriptive text and a 'Target Assignments' table. The table lists two components: 'GWMDB' (Enterprise Application) and 'GW\_MDB\_Bean.jar' (EJB). The 'Current Targets' column shows 'Cluster-App' for 'GWMDB' and '(None specified)' for 'GW\_MDB\_Bean.jar'.

Component	Type	Current Targets
GWMDB	Enterprise Application	Cluster-App
GW_MDB_Bean.jar	EJB	(None specified)

## 2) Health Should be OK if JMS is configured properly, otherwise Warning will be displayed

**Change Center**

**View changes and restarts**

Configuration editing is enabled. Future changes will automatically be activated as you modify, add or delete items in this domain.

**Domain Structure**

- Environment
  - Deployments**
- Services
  - Messaging
    - JMS Servers
    - Store-and-Forward Agents
    - JMS Modules
    - Path Services
  - Bridges
  - Data Sources
  - Persistent Stores
  - Foreign JNDI Providers
  - Work Contexts

**How do I...**

- Install an Enterprise application
- Configure an Enterprise application
- Update (redeploy) an Enterprise application
- Start and stop a deployed Enterprise application
- Monitor the modules of an Enterprise application

Home Log Out Preferences Record Help Welcome, weblogic Connected to: base\_domain

Home > Summary of Environment > Summary of Servers > Summary of Deployments > JMS Modules > MDB\_MODULE > Summary of Environment > Summary of Servers > Summary of Deployments > GWMDB > Summary of Deployments

**Summary of Deployments**

Control Monitoring

This page displays a list of Java EE applications and stand-alone application modules that have been installed to this domain. Installed applications and modules can be started, stopped, updated (redeployed), or deleted from the domain by first selecting the application name and using the controls on this page.

To install a new application or module for deployment to targets in this domain, click the Install button.

**Customize this table**

**Deployments**

Install Update Delete Start Stop Showing 1 to 5 of 5 Previous Next

<input type="checkbox"/>	Name	State	Health	Type	Deployment Order
<input type="checkbox"/>	FCUBSApp	Active	OK	Enterprise Application	100
<input type="checkbox"/>	GWEJB	Active	OK	Enterprise Application	100
<input type="checkbox"/>	GWMDB	Active	OK	Enterprise Application	100
<input type="checkbox"/>	jax-rs(1.1.1.9)	Active		Library	100
<input type="checkbox"/>	SWEJB	Active	OK	Enterprise Application	100

Install Update Delete Start Stop Showing 1 to 5 of 5 Previous Next

## 8. Frequently Asked Questions

### 8.1 Application and JMS Cluster Deployed on Same Cluster

Application and JMS Module can be deployed on the same cluster. In this document both are on different clusters, however it is possible to deploy on the one cluster. When it is deployed on same cluster then

- 1) Foreign Server Creation is not required
- 2) Targets should be given accordingly during Sub Deployment Creation

### 8.2 Application Shows Warning upon Restart of Managed Servers

Managed Servers Start Order

- 1) Stop all managed servers.
- 2) Start only the JMS Cluster managed servers.
- 3) After these are started then start the App Cluster managed servers.

Even after proper JMS setup when the managed servers are restarted Health of the Application is Warning

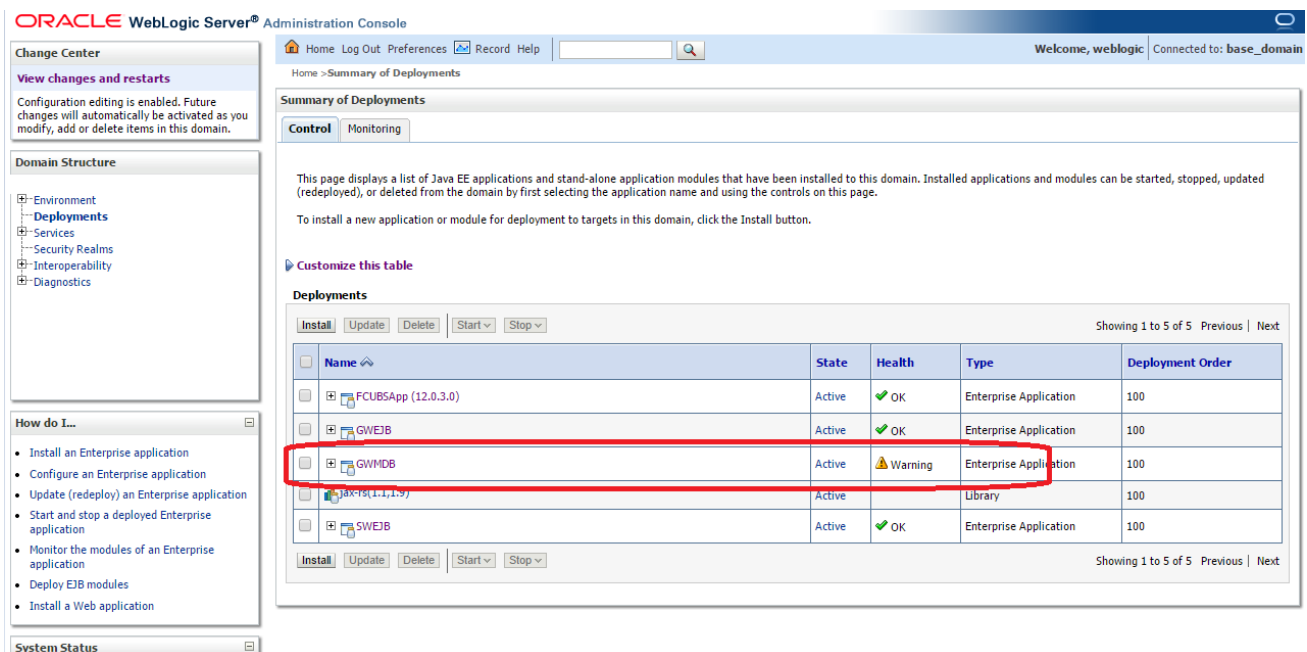

The screenshot shows the Oracle WebLogic Server Administration Console. The main content area displays the 'Summary of Deployments' page. A table lists the deployed applications and their health status. The application 'GWMDB' is highlighted with a red box, showing a 'Warning' health status. The table has columns for Name, State, Health, Type, and Deployment Order.

Name	State	Health	Type	Deployment Order
FCUBSApp (12.0.3.0)	Active	OK	Enterprise Application	100
GWEJB	Active	OK	Enterprise Application	100
<b>GWMDB</b>	Active	<b>Warning</b>	Enterprise Application	100
JAX-WS (1.1.1.9)	Active		Library	100
SWEJB	Active	OK	Enterprise Application	100

- 1) Force Stop the Application
- 2) Then Start the Application, this would resolve the Warning and the Health of Deployment is changed to OK.

## 8.3 Securing File Store Data

In order to properly secure file store data, set appropriate directory permissions on all file store directories. If data encryption is required, use appropriate third-party encryption software.

## 8.4 t3s Protocol

To secure the communication with the JMS Server use t3s protocol instead of t3. This is applicable when connecting to the connection factory to send or receive messages and also in the JNDI Connection URL provided in foreign server creation.

NOTE: when using the t3s protocol SSL Listen Port Enabled should be checked in server template and the port number used in the URL should be secure port.

## 8.5 How to Test the Deployment

1) Navigate to Services → JMS Modules → JMS\_MODULE → MDB\_QUEUE → MONITORING

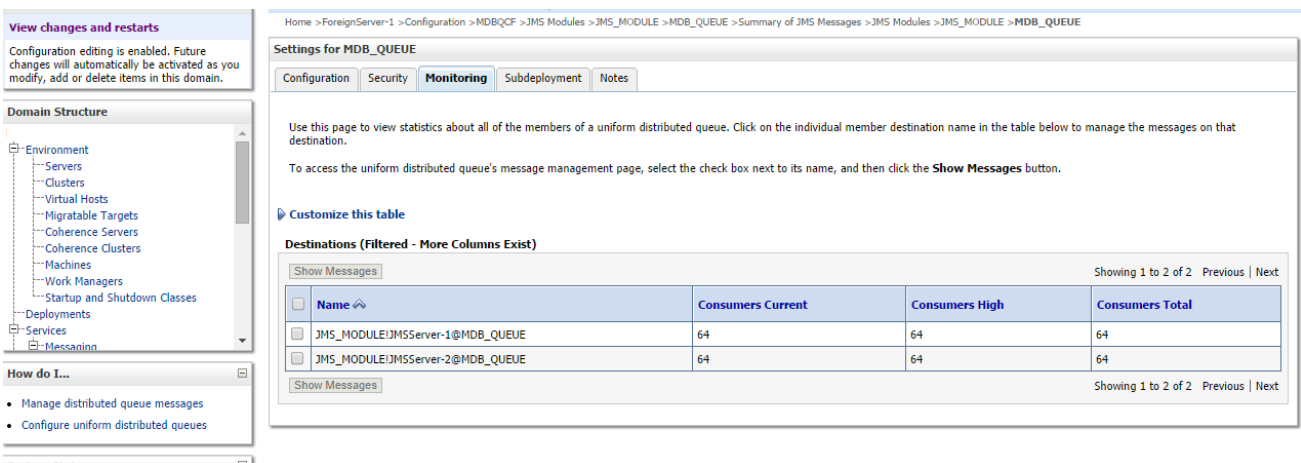

View changes and restarts  
Configuration editing is enabled. Future changes will automatically be activated as you modify, add or delete items in this domain.

Domain Structure

- Environment
  - Servers
  - Clusters
  - Virtual Hosts
  - Migratable Targets
  - Coherence Servers
  - Coherence Clusters
  - Machines
  - Work Managers
  - Startup and Shutdown Classes
- Deployments
- Services
  - Messaging

How do I...

- Manage distributed queue messages
- Configure uniform distributed queues

Home > ForeignServer-1 > Configuration > MDBQCF > JMS Modules > JMS\_MODULE > MDB\_QUEUE > Summary of JMS Messages > JMS Modules > JMS\_MODULE > MDB\_QUEUE

Settings for MDB\_QUEUE

Configuration Security **Monitoring** Subdeployment Notes

Use this page to view statistics about all of the members of a uniform distributed queue. Click on the individual member destination name in the table below to manage the messages on that destination.

To access the uniform distributed queue's message management page, select the check box next to its name, and then click the **Show Messages** button.

Customize this table

Destinations (Filtered - More Columns Exist)

Show Messages Showing 1 to 2 of 2 Previous | Next

<input type="checkbox"/>	Name ↕	Consumers Current	Consumers High	Consumers Total
<input type="checkbox"/>	JMS_MODULE:JMS5Server-1@MDB_QUEUE	64	64	64
<input type="checkbox"/>	JMS_MODULE:JMS5Server-2@MDB_QUEUE	64	64	64

Show Messages Showing 1 to 2 of 2 Previous | Next

2) Select any one Server and Click on Show Messages

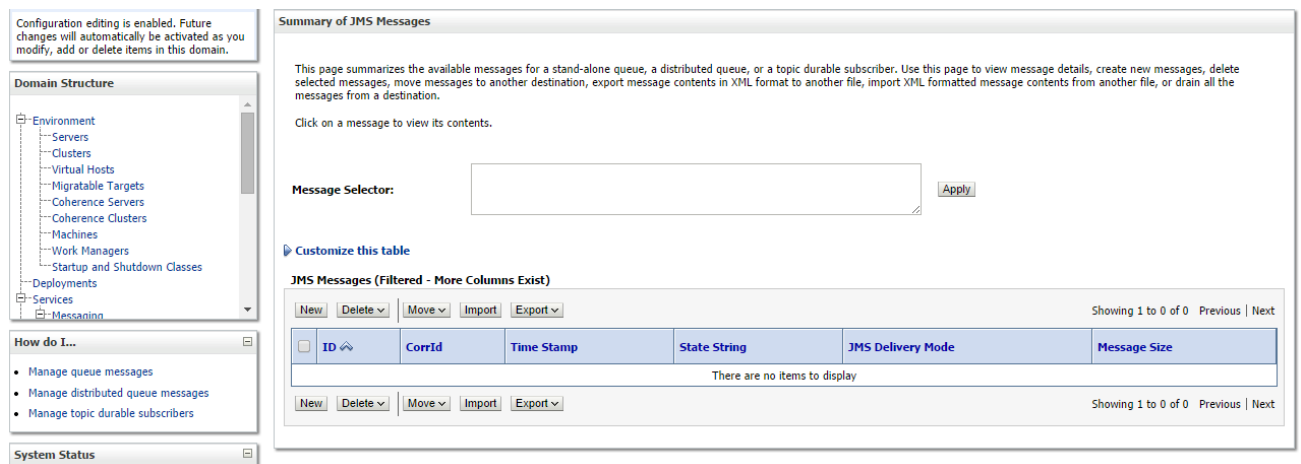

Configuration editing is enabled. Future changes will automatically be activated as you modify, add or delete items in this domain.

Domain Structure

- Environment
  - Servers
  - Clusters
  - Virtual Hosts
  - Migratable Targets
  - Coherence Servers
  - Coherence Clusters
  - Machines
  - Work Managers
  - Startup and Shutdown Classes
- Deployments
- Services
  - Messaging

How do I...

- Manage queue messages
- Manage distributed queue messages
- Manage topic durable subscribers

System Status

Summary of JMS Messages

This page summarizes the available messages for a stand-alone queue, a distributed queue, or a topic durable subscriber. Use this page to view message details, create new messages, delete selected messages, move messages to another destination, export message contents in XML format to another file, import XML formatted message contents from another file, or drain all the messages from a destination.

Click on a message to view its contents.

Message Selector:

Customize this table

JMS Messages (Filtered - More Columns Exist)

New Delete Move Import Export Showing 1 to 0 of 0 Previous | Next

<input type="checkbox"/>	ID ↕	CorrId	Time Stamp	State String	JMS Delivery Mode	Message Size
There are no items to display						

New Delete Move Import Export Showing 1 to 0 of 0 Previous | Next

### 3) Click on New and enter the Message in Body and Click on OK

The screenshot shows the 'Produce JMS Message' dialog box. On the left, there is a 'Change Center' sidebar with sections for 'View changes and restarts', 'Domain Structure', 'How do I...', and 'System Status'. The main area contains the 'Produce JMS Message' form with the following fields:

- Type:
- Correlation ID:
- Expiration:
- Priority:
- Delivery Mode:
- Delivery Time:
- Redelivery Limit:
- Body:

### 4) Message is Sent

The screenshot shows the 'Summary of JMS Messages' page. A green message at the top states 'JMS message sent successfully'. Below this, there is a 'Message Selector' field and an 'Apply' button. A table titled 'JMS Messages (Filtered - More Columns Exist)' displays the details of the sent message:

ID	CorrId	Time Stamp	State String	JMS Delivery Mode	Message Size
<input type="checkbox"/> ID:<257876.1411126889162.0>		Fri Sep 19 17:11:29 IST 2014	receive transaction	Persistent	472

### 5) Verify at backend or in the MDB log if the message is processed successfully.



## 8.6 Increase maximum number of message-driven bean threads

Default number of consumers for an MDB is 16. To increase or restrict this number create Custom Work Manager with a Max Threads Constraint in conjunction with MDBs.

The solution is to create a work manager with a max threads constraint and assign the proxy services dispatch policy to this work manager.

Steps to create custom work manager

- 1) Modify the MDB deployment descriptor and redeploy the EAR
- 2) Create Custom Workmanager and add constraints to limit the number of the max MDB threads

### 8.6.1 Modify weblogic-ejb-jar.xml

- 1) Add below line to the weblogic-ejb-jar.xml of the MDB Ear  
<dispatch-policy>GWMDBWM</dispatch-policy>

```
weblogic-ejb-jar.xml * x
<?xml version="1.0" encoding="UTF-8"?>
<weblogic-ejb-jar
  xmlns="http://xmlns.oracle.com/weblogic/weblogic-ejb-jar"
  xmlns:xsi="http://www.w3.org/2001/XMLSchema-instance" xsi:schemaLocation="http://xmlns.oracle.com/weblogic/weblogic-ejb-jar http://xmlns.oracle
  <weblogic-enterprise-bean>
    <ejb-name>GWMDB</ejb-name>
    <!-- EJB Reference Descriptions STARTS-->
    <!-- EJB Resource Reference Descriptions STARTS-->
    <resource-description>
      <res-ref-name>FLEXTEST_WORLD</res-ref-name>
      <jndi-name>FLEXTEST_WORLD</jndi-name>
    </resource-description>
    <resource-description>
      <res-ref-name>MDBQCF</res-ref-name>
      <jndi-name>MDBQCF</jndi-name>
    </resource-description>
    <!-- EJB Resource Reference Descriptions ENDS-->
    <!-- EJB Resource environment Reference Descriptions STARTS-->
    <resource-env-description>
      <resource-env-ref-name>MDB_QUEUE_RESPONSE</resource-env-ref-name>
      <jndi-name>MDB_QUEUE_RESPONSE</jndi-name>
    </resource-env-description>
    <resource-env-description>
      <resource-env-ref-name>MDB_QUEUE_DLQ</resource-env-ref-name>
      <jndi-name>MDB_QUEUE_DLQ</jndi-name>
    </resource-env-description>
    <resource-env-description>
      <resource-env-ref-name>SW_MDB_QUEUE_RESPONSE</resource-env-ref-name>
      <jndi-name>SW_MDB_QUEUE_RESPONSE</jndi-name>
    </resource-env-description>
    <!-- EJB Resource environment Reference Descriptions ENDS-->
    <!-- EJB Reference Descriptions ENDS -->
    <dispatch-policy>GWMDBWM</dispatch-policy>
  </weblogic-enterprise-bean>
</weblogic-ejb-jar>
```

- 2) Remove if any of the below tags present in weblogic-ejb-jar.xml  
max-beans-in-free-pool and initial-beans-in-free-pool
- 3) Save the ear file and redeploy the EAR file.

## 8.6.2 Work Manager Creation

- 1) Login into weblogic console, navigate to Domain → Environment → WorkManager  
Create new workmanager with the name GWMDBWM(as mentioned in property file) by following below steps

Oracle WebLogic Server Administration Console 12c

Home Log Out Preferences Record Help

Welcome, weblogic Connected to: FCUBSDomain

Home > Summary of Work Managers > MaxThreadsConstraint-0 > Summary of Work Managers > WorkManager-0 > Summary of Work Managers > MaxThreadsConstraint-0 > Summary of Servers > Summary of Environment > Summary of Servers > Summary of Work Managers

### Create a New Work Manager Component

Back Next Finish Cancel

**Select Work Manager Definition type**

What type of Work Manager, Request Class or Constraint do you want to create?

- Work Manager**
- Response Time Request Class
- Fair Share Request Class
- Context Request Class
- Maximum Threads Constraint
- Minimum Threads Constraint
- Capacity Constraint

Back Next Finish Cancel

Oracle WebLogic Server Administration Console 12c

Home Log Out Preferences Record Help

Welcome, weblogic Connected to: FCUBSDomain

Home > Summary of Work Managers > MaxThreadsConstraint-0 > Summary of Work Managers > WorkManager-0 > Summary of Work Managers > MaxThreadsConstraint-0 > Summary of Servers > Summary of Environment > Summary of Servers > Summary of Work Managers

### Create a New Work Manager Component

Back Next Finish Cancel

**Work Manager Properties**

The following properties will be used to identify your new Work Manager.

\* Indicates required fields

What would you like to name your new Work Manager?

\* Name:

Back Next Finish Cancel

Oracle WebLogic Server Administration Console 12c

Home Log Out Preferences Record Help

Welcome, weblogic Connected to: FCUBSDomain

Home > Summary of Work Managers > MaxThreadsConstraint-0 > Summary of Work Managers > WorkManager-0 > Summary of Work Managers > MaxThreadsConstraint-0 > Summary of Servers > Summary of Environment > Summary of Servers > Summary of Work Managers

### Create a New Work Manager Component

Back Next Finish Cancel

**Select deployment targets**

You can target the Work Manager to any of these WebLogic Server instances or Clusters. Select the same targets on which you will deploy applications that reference the Work Manager.

**Available targets :**

<b>Servers</b>	
<input type="checkbox"/>	AdminServer
<b>Clusters</b>	
<input checked="" type="checkbox"/>	<b>Cluster-App</b>
<input type="radio"/>	All servers in the cluster
<input type="checkbox"/>	<b>Cluster-JMS</b>
<input type="radio"/>	All servers in the cluster

Back Next Finish Cancel

**ORACLE WebLogic Server Administration Console 12c**

Home Log Out Preferences Record Help Welcome, weblogic Connected to: FCUBSDomain

Home > Summary of Work Managers > MaxThreadsConstraint-0 > Summary of Work Managers > WorkManager-0 > Summary of Work Managers > MaxThreadsConstraint-0 > Summary of Servers > Summary of Environment > Summary of Servers > Summary of Work Managers

**Change Center**  
View changes and restarts  
Pending changes exist. They must be activated to take effect.  
[Activate Changes] [Undo All Changes]

**Domain Structure**  
FCUBSDomain  
Environment  
Servers  
Clusters  
Coherence Clusters  
Machines  
Virtual Hosts  
**Work Managers**  
Startup and Shutdown Classes  
Deployments  
Services  
Security Realms  
Interoperability  
Diagnostics

**Messages**  
Work Manager created successfully

**Summary of Work Managers**  
A Work Manager defines a set of request classes and thread constraints that manage work performed by WebLogic Server instances. This page displays the global Work Managers, request classes and thread constraints defined for this domain.  
Global Work Managers are defined at the domain level. You can also define application-level and module-level Work Managers.

Customize this table

**Global Work Managers, Request Classes and Constraints**

Name	Type	Targets
GWMBWVM	Work Manager	Cluster-App

Showing 1 to 1 of 1 Previous | Next

2) Create new Max Thread Constraint and in the Count field give the desired thread count

**ORACLE webLogic server Administration Console 12c**

Home Log Out Preferences Record Help Welcome, weblogic Connected to: FCUBSDomain

Home > Summary of Work Managers > MaxThreadsConstraint-0 > Summary of Work Managers > WorkManager-0 > Summary of Work Managers > MaxThreadsConstraint-0 > Summary of Servers > Summary of Environment > Summary of Servers > Summary of Work Managers

**Change Center**  
View changes and restarts  
Pending changes exist. They must be activated to take effect.  
[Activate Changes] [Undo All Changes]

**Domain Structure**  
FCUBSDomain  
Environment  
Servers  
Clusters  
Coherence Clusters  
Machines  
Virtual Hosts  
Work Managers  
Startup and Shutdown Classes  
Deployments  
Services  
Security Realms  
Interoperability  
Diagnostics

**How do I...**  
Create application-scoped constraints  
Create application-scoped request classes  
Create application-scoped Work Managers

**Create a New Work Manager Component**  
[Back] [Next] [Finish] [Cancel]

**Select Work Manager Definition type**  
What type of Work Manager, Request Class or Constraint do you want to create?

- Work Manager
- Response Time Request Class
- Fair Share Request Class
- Context Request Class
- Maximum Threads Constraint**
- Minimum Threads Constraint
- Capacity Constraint

[Back] [Next] [Finish] [Cancel]

**ORACLE webLogic server Administration Console 12c**

Home Log Out Preferences Record Help Welcome, weblogic Connected to: FCUBSDomain

Home > Summary of Work Managers > MaxThreadsConstraint-0 > Summary of Work Managers > WorkManager-0 > Summary of Work Managers > MaxThreadsConstraint-0 > Summary of Servers > Summary of Environment > Summary of Servers > Summary of Work Managers

**Change Center**  
View changes and restarts  
Pending changes exist. They must be activated to take effect.  
[Activate Changes] [Undo All Changes]

**Domain Structure**  
FCUBSDomain  
Environment  
Servers  
Clusters  
Coherence Clusters  
Machines  
Virtual Hosts  
Work Managers  
Startup and Shutdown Classes  
Deployments  
Services  
Security Realms  
Interoperability  
Diagnostics

**How do I...**  
Create application-scoped constraints

**Create a New Work Manager Component**  
[Back] [Next] [Finish] [Cancel]

**Maximum Threads Constraint Properties**  
The following properties will be used to identify your new Max Threads Request Class.  
\* Indicates required fields

What would you like to name the new Maximum Threads Constraint?

\* Name: MaxThreadsConstraint-0

What is the maximum number of concurrent threads to allocate for requests? Enter either a fixed thread count or the name of a Data Source whose size will be used for the constraint.

Count: 25

Data Source:

[Back] [Next] [Finish] [Cancel]

Change Center

View changes and restarts

Pending changes exist. They must be activated to take effect.

Activate Changes

Undo All Changes

Domain Structure

FCUBSDomain

- Environment
  - Servers
  - Clusters
    - Coherence Clusters
    - Machines
    - Virtual Hosts
    - Work Managers
    - Startup and Shutdown Classes
- Deployments
- Services
- Security Realms
- Interoperability
- Diagnostics

How do I...  
 • Create application-scoped constraints  
 • Create application-scoped request classes  
 • Create application-scoped Work Managers

Home Log Out Preferences Record Help

Welcome, weblogic Connected to: FCUBSDomain

Home > Summary of Work Managers > MaxThreadsConstraint-0 > Summary of Work Managers > WorkManager-0 > Summary of Work Managers > MaxThreadsConstraint-0 > Summary of Servers > Summary of Environment > Summary of Servers > Summary of Work Managers

Create a New Work Manager Component

Back Next Finish Cancel

Select deployment targets

You can target the Work Manager to any of these WebLogic Server instances or Clusters. Select the same targets on which you will deploy applications that reference the Work Manager.

Available targets :

Servers

AdminServer

Clusters

Cluster-App  
 All servers in the cluster

Cluster-JMS  
 All servers in the cluster

Back Next Finish Cancel

Change Center

View changes and restarts

Pending changes exist. They must be activated to take effect.

Activate Changes

Undo All Changes

Domain Structure

FCUBSDomain

- Environment
  - Servers
  - Clusters
    - Coherence Clusters
    - Machines
    - Virtual Hosts
    - Work Managers
    - Startup and Shutdown Classes
- Deployments
- Services
- Security Realms
- Interoperability
- Diagnostics

How do I...  
 • Create application-scoped constraints  
 • Create application-scoped request classes  
 • Create application-scoped Work Managers

Home Log Out Preferences Record Help

Welcome, weblogic Connected to: FCUBSDomain

Home > Summary of Work Managers > MaxThreadsConstraint-0 > Summary of Work Managers > WorkManager-0 > Summary of Work Managers > MaxThreadsConstraint-0 > Summary of Servers > Summary of Environment > Summary of Servers > Summary of Work Managers

Messages

Maximum Threads Constraint created successfully

Summary of Work Managers

A Work Manager defines a set of request classes and thread constraints that manage work performed by WebLogic Server instances. This page displays the global Work Managers, request classes and thread constraints defined for this domain.

Global Work Managers are defined at the domain level. You can also define application-level and module-level Work Managers.

Customize this table

Global Work Managers, Request Classes and Constraints

New Clone Delete Showing 1 to 2 of 2 Previous Next

Name	Type	Targets
GWMBWM	Work Manager	Cluster-App
MaxThreadsConstraint-0	Maximum Threads Constraint	Cluster-App

New Clone Delete Showing 1 to 2 of 2 Previous Next

3) Modify the newly created workmanager and assign the Maximum Thread Constraint that is created in above step.

View changes and restarts

Pending changes exist. They must be activated to take effect.

Activate Changes

Undo All Changes

Domain Structure

FCUBSDomain

- Environment
  - Servers
  - Clusters
    - Coherence Clusters
    - Machines
    - Virtual Hosts
    - Work Managers
    - Startup and Shutdown Classes
- Deployments
- Services
- Security Realms
- Interoperability
- Diagnostics

How do I...  
 • Create application-scoped constraints  
 • Create application-scoped request classes  
 • Create application-scoped Work Managers  
 • Create global constraints  
 • Create global request classes  
 • Create global Work Managers

System States

Health of Running Servers

Home > MaxThreadsConstraint-0 > Summary of Work Managers > WorkManager-0 > Summary of Work Managers > MaxThreadsConstraint-0 > Summary of Servers > Summary of Environment > Summary of Servers > Summary of Work Managers > GWMBWM

Settings for GWMBWM

Configuration Targets Notes

Save

Use this page to define the request classes and constraints for the selected global Work Manager.

Name: (No value specified) The user-specified name of this MBean instance. More Info...

Request Class: (None configured) New A request class associated with this Work Manager. This may be a FairShareRequestClass, ResponseTimeRequestClass, or a ContentRequestClass. More Info...

Minimum Threads Constraint: (None configured) New The minimum number of threads allocated to resolve deadlocks. More Info...

Maximum Threads Constraint: (None configured) New The maximum number of concurrent threads that can be allocated to execute requests. More Info...

Capacity Constraint: (None configured) New The total number of requests that can be queued or executing before WebLogic Server begins rejecting requests. More Info...

Stuck Thread Action: Use server default behavior Specify how stuck threads should be detected, and what action to take should they occur. More Info...

Max Stuck Thread Time: 0 Time after which a executing thread is declared as stuck. More Info...

Stuck Thread Count: 0 Number of stuck threads after which the WorkManager is shutdown. More Info...

Resume When Unstuck Whether to resume work manager once the stuck threads were cleared. More Info...

Save

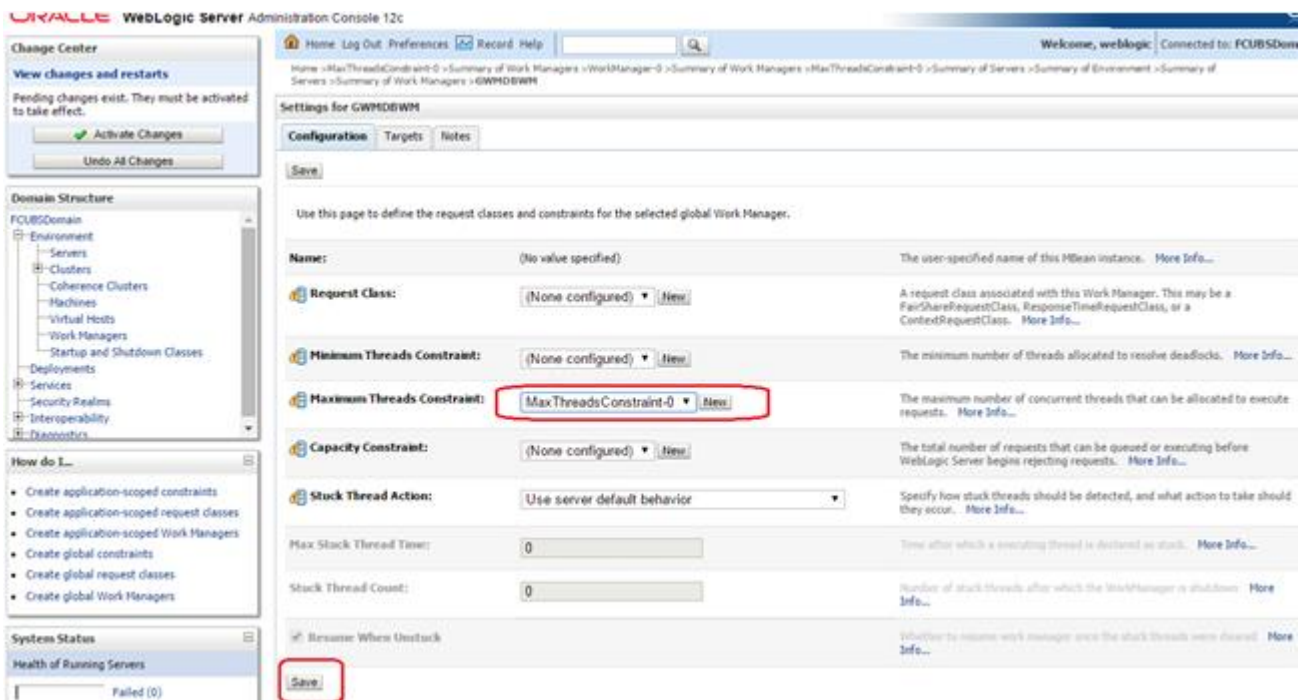

- 4) Restart managed servers and notice the change in the number of consumers for the QUEUE's.

## 8.7 How High Availability is achieved

- 1) Application Server:  
MDB\_MODULE and the GWEJB ear are deployed in a cluster. Cluster has 4 managed servers, if any server goes down then the messages are processed by other managed servers.
- 2) JMS Provider:  
JMS is deployed on 2 managed servers, JMSServer1 and JMSServer2, if any one goes down other will handle the messages.
- 3) FileStore:  
File store is a cluster file system or database where if one node goes down then other will handle the requests.
- 4) DB Server:  
Database is installed in RAC mode where it has more than 1 node, if a node goes down then other nodes will handle messages.

## **8.8 How to setup for Scheduler/Notifications**

The above document can be used for setting up JMS for scheduler/notifications but additional queues and connection factory needs to be created.

## **8.9 What other modules uses JMS Queue's**

JMS is used by following modules, relevant queues and factories needs to be created additionally

- 1) EMS for swift messages
- 2) GI for upload
- 3) ELCM
- 4) BIP

## **8.10 References**

- 1) FCUBS\_12.1\_Weblogic12c\_Middleware\_Practices.doc
- 2) GATEWAY\_Applications\_WL.doc
- 3) Resource\_Creation\_WL.doc



JMS Cluster Configuration 12c

[February] [2021]

Version 14.4.0.3.0

Oracle Financial Services Software Limited  
Oracle Park  
Off Western Express Highway  
Goregaon (East)  
Mumbai, Maharashtra 400 063  
India

Worldwide Inquiries:

Phone: +91 22 6718 3000

Fax: +91 22 6718 3001

<https://www.oracle.com/industries/financial-services/index.html>

Copyright © 2020, 2021 Oracle and/or its affiliates. All rights reserved.

Oracle and Java are registered trademarks of Oracle and/or its affiliates. Other names may be trademarks of their respective owners.

**U.S. GOVERNMENT END USERS:** Oracle programs, including any operating system, integrated software, any programs installed on the hardware, and/or documentation, delivered to U.S. Government end users are "commercial computer software" pursuant to the applicable Federal Acquisition Regulation and agency-specific supplemental regulations. As such, use, duplication, disclosure, modification, and adaptation of the programs, including any operating system, integrated software, any programs installed on the hardware, and/or documentation, shall be subject to license terms and license restrictions applicable to the programs. No other rights are granted to the U.S. Government.

This software or hardware is developed for general use in a variety of information management applications. It is not developed or intended for use in any inherently dangerous applications, including applications that may create a risk of personal injury. If you use this software or hardware in dangerous applications, then you shall be responsible to take all appropriate failsafe, backup, redundancy, and other measures to ensure its safe use. Oracle Corporation and its affiliates disclaim any liability for any damages caused by use of this software or hardware in dangerous applications.

This software and related documentation are provided under a license agreement containing restrictions on use and disclosure and are protected by intellectual property laws. Except as expressly permitted in your license agreement or allowed by law, you may not use, copy, reproduce, translate, broadcast, modify, license, transmit, distribute, exhibit, perform, publish or display any part, in any form, or by any means. Reverse engineering, disassembly, or decompilation of this software, unless required by law for interoperability, is prohibited.

The information contained herein is subject to change without notice and is not warranted to be error-free. If you find any errors, please report them to us in writing.

This software or hardware and documentation may provide access to or information on content, products and services from third parties. Oracle Corporation and its affiliates are not responsible for and expressly disclaim all warranties of any kind with respect to third-party content, products, and services. Oracle Corporation and its affiliates will not be responsible for any loss, costs, or damages incurred due to your access to or use of third-party content, products, or services.